

# Agilent 16900 Series Logic Analysis System Mainframes

Data Sheet

## Conquer your toughest digital debug problems while staying within your budget

The Agilent 16900 Series modular logic analysis mainframes deliver the performance you need to conquer your toughest digital debug problems. You get accurate and reliable measurements for today's complex circuits, with expandability and performance headroom to cover future technology trends. In addition, the intuitive user interface gives you the ultimate in productivity without sacrificing performance or capability. You get performance and intuitive usability at a price you can afford.

## Expand your system as your needs evolve

Expandability is the key to the long-term value of the Agilent 16900 Series logic analysis systems. Purchase the capability you need now, then expand as your needs evolve. Maximize mainframe usage by operating them separately, then connecting them together for complex, high-channel-count, multiple-bus applications. Whether you are doing simple hardware debug, real-time analysis of instruction execution, hardware/software integration, signal-quality analysis or complex system validation, you have a system that meets each of your long-term digital measurement needs.

## Spend more time designing and less time learning how to use your tools

If you want to focus on solving your digital debug problems, you need to be able to quickly master your debug tools. The 16900 Series logic analysis mainframes let you set up measurements easily and navigate through your data quickly with an intuitive user interface and familiarity of Windows® XP Professional.

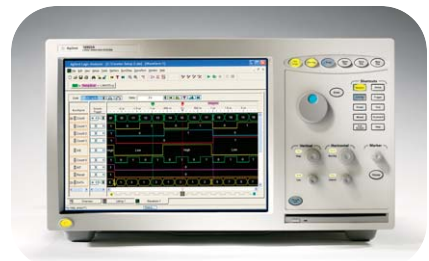

Figure 1. The Agilent 16901A, 16900A and 16902A modular logic analysis systems.



Agilent Technologies

**The flexibility you need to debug your design your way**

Increase your productivity with a variety of operating modes that maximize your analyzer's usage. Whether you work alone at a bench or with team members distributed around the world, the 16900 Series provides a use model that easily integrates into your debug environment.

**Work at your bench** – Operate the analyzer via touch screen, mouse or keyboard.

**Expand view across multiple monitors** – Get the most comprehensive view of your data with extended desktop viewing.

**Remotely control and monitor the logic analyzer** – Access a remote logic analyzer via built-in Windows XP desktop sharing. Receive e-mail when the logic analyzer triggers.

**Work offline** – Increase equipment and team productivity. View and analyze captured data on a PC while the logic analyzer makes other measurements. Also, create setups for your next round of measurements.

**Run automated tests** – Execute a series of tests via the ASCII remote programming interface or Microsoft DCOM.

**Offload data for custom analysis** – Move data quickly over the optional Gbit LAN connection to an external PC.

**Combine mainframes to expand measurement capability** – Use mainframes individually, then connect them together when you need to analyze complex, multiple-bus problems.

**Maximize system performance** – Augment the logic analyzer's high performance with the latest PC or server technology to control the logic analyzer and analyze data.

**Share information with others** – Save your results to shared drives.

**Document your findings** – Print screen shots to networked printers and cut and paste data into other software applications.

**Comply with your company's network standards** – Add anti-virus software to the open Windows XP Pro-based logic analyzer.

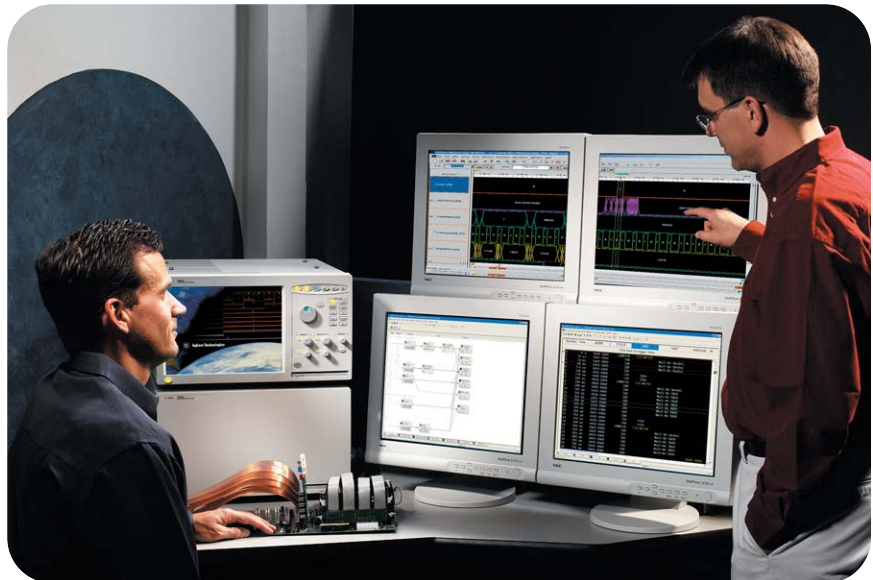

Figure 2. Get the most comprehensive view of your data with extended desktop viewing.

**16900 Series mainframe — the power you need at a price you can afford**

The mainframe you select is the foundation of your system. The Agilent 16900 Series includes a range of powerful logic analysis mainframes that deliver the performance you need at a price you can afford. You get accurate and reliable measurements, for today’s complex systems, plus expandability and performance headroom to cover future technology trends.

**Key things to consider when selecting a 16900 Series mainframe:**

- **Number of module slots —** Determine the number of measurement modules required for your specific measurement need. Also consider having additional slots for future needs.
- **Multiframe Pro —** 16900 Series mainframes can always be used as a standalone unit. In some instances your channel needs may surpass a single mainframe. Multiframe Pro allows you to connect multiple frames into one measurement system with a single interface control.
- **Display and resolution —** If you prefer to operate the analyzer directly from the front panel, select a mainframe with a large, built-in touch display. All 16900 Series mainframes can also be used with external monitors.
- **PCI expansion slots —** Customize your logic analyzer peripherals by adding PCI cards for a specific capability like multiple monitor video.

**Select the 16900 Series mainframe that meets your requirements**

Agilent model number	16901A	16902A	16900A
Number of module slots	2	6	6
Multiframe Pro	Yes	Yes	Yes
Display and resolution	Built-in color touch screen, 15 inch (38.1 cm), 1024 x 768; supports up to four external monitors up to 1600 x 1200	Built-in color touch screen display, 12.1 inch at 800 x 600, supports up to four external monitors at up to 1600 x 1200 (with PCI video card)	Uses external display. Supports up to four external displays at up to 1600 x 1200 (with PCI video card)
PCI expansion slots	1 full profile	1 full profile, 1 low profile	1 full profile, 1 low profile

**Table 1. Agilent modular 16900 Series mainframes.**

**Agilent 16900 Series Features**

Modularity and Expandability	Protect your long-term investment. Start with the capability you need now, then add measurement modules or expand the number of frames in the system as your needs evolve.
Intuitive user interface	Quickly master the logic analyzer due to the award winning usability and familiarity of Windows XP Pro.
Hosted Power Mode and Offline Analysis	Achieve the ultimate in performance by hosting the logic analyzer application software on your fastest server to remotely control the logic analyzer and analyze data.
Open PC platform	Accelerate your debugging process with an extensive range of optional software analysis tools. Protect your data and make your logic analyzer compliant with your network environment with anti-virus software. Share your work and communicate results easily via LAN or USB flash drives
Full programmability	Modify any measurement setting using COM via LAN.
Wide range of use models	Increase your productivity and maximize your analyzer’s usage by local or widely-distributed teams. (See page 2)

**Table 2. Key features and benefits of Agilent 16900 Series logic analysis systems.**

### Modular expandability protects your long-term investment

Configure a custom logic analysis system with analyzer modules to fit your performance and price needs. Protect your investment by upgrading memory depths or state speeds as your needs change.

### Measurement Module Support

The 16900 Series supports the following measurement modules:

#### Timing/State Modules

- 16951B
- 16950B
- 16950A
- 16910A, 16911A
- 16760A
- 16753A, 16754A, 16755A, 16756A
- 16750A/B, 16751A/B, 16752A/B
- 16740A, 16741A, 16742A

#### Pattern Generator Module

- 16720A

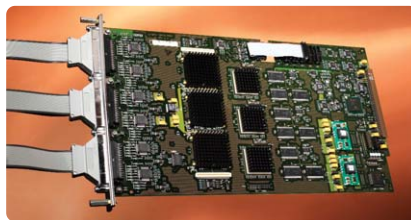

**Figure 3. Combine multiple acquisition modules when you need to measure across many channels.**



**Figure 4. Modularity provides configuration flexibility to meet your measurement needs—now and in the future.**

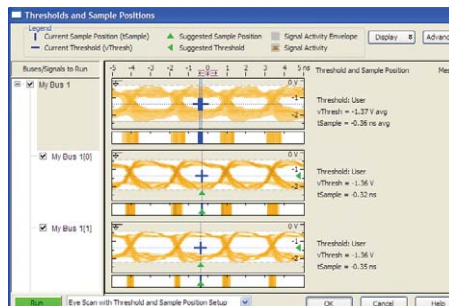

**Figure 5. Identify problem signals quickly by viewing eye diagrams across all buses and signals simultaneously.**

	Half channels	Full channels
Max clock speed	300 MHz	180 MHz
Max memory depth	16 M Vectors	8 M Vectors
Channels per module	24	48
Max number of channels per time base	120	240
Stimulus commands	Initialize, Block, Repeat, and Break Macros	
Logic levels supported	5 V TTL, 3 state TTL, 3 state CMOS, 3 state 3.3 V ECL, 5 V PECL, 3.3 V LVPECL, 3 state 2.5 V, 3 state 1.8 V, LVDS	

<sup>1</sup> Order at least one clock pod for each module used as a master and at least one data pod for every 8 output channels.

**Table 3. Add a pattern generator module to drive down risk early in product development.**

## Choose the modules that meet your specific needs

Agilent model number	16910A <sup>2,3</sup> /16911A <sup>2,3</sup>	16950B <sup>2,3</sup> /16951B <sup>2</sup>	16760A <sup>2</sup>
Channels per module	102 / 68	68	34
Max channels on a single timebase and trigger	510/340	340	170
Memory depths	256 K: Opt 256 1 M: Opt 001 4 M: Opt 004 16 M: Opt 016 32 M: Opt 032	16950B options: 1 M: Opt 001 4 M: Opt 004 16 M: Opt 016 32 M: Opt 032 64 M: Opt 064 16951B: 256 M	64 M
High speed timing rate <sup>1</sup>	4 GHz (250 ps) with 64 K depth	4 GHz (250 ps) with 64 K depth	
Max deep memory timing sample rate (full/half channel)	1.0 GHz (1.0 ns)/ 500 MHz (2.0 ns)	1.2 GHz (833 ps)/ 600 MHz (1.67 ns)	800 MHz
Transitional timing	500 MHz (2.0 ns)	600 MHz (1.67 ns)	400 MHz (2.5 ns)
Max state clock rate	250 MHz (Opt 250) 450 MHz (Opt 500)	667 MHz	800 MHz
Max state data rate	250 Mb/s (Opt 250) 500 Mb/s (Opt 500)	667 Mb/s (DDR) 1066 Mb/s (Dual Sample)	1.5 Gb/s
Voltage threshold ranges	-5 V to 5 V (10 mV increments)	-3 V to 5 V (10 mV increments)	-3 V to 5 V (10 mV increments)
Eye finder and eye scan support	Yes	Yes	Yes
Supported signal types	Single-ended	Single-ended and differential	Single-ended and differential
Probe compatibility	40-pin cable connector	90-pin cable connector	90-pin cable connector

<sup>1</sup> All channels, all the time, simultaneous state and timing through same probe.

<sup>2</sup> Probes are ordered separately. Please specify probes when ordering to ensure the correct connection between your logic analyzer and the device under test.

<sup>3</sup> Specify desired memory depth, state clock and data rate using available options. Feature also available via software upgrade to existing module.

**Table 4. Select the logic analyzer modules that best suit your requirements.**

**Headroom for your future needs  
(Extend the life of your equipment)**

Easily upgrade your 16900 Series modules. “Turn on” additional memory depth and state speed when you need more. Purchase the capability you need now, then upgrade as your needs evolve.

16910A	Upgrade max. state speed from 250 MHz to 450 MHz and max. data rate from 250 Mb/s to 500 Mb/s
16911A	
Memory depth options 256 K, 1 M, 4 M, 16 M or 32 M	
16950A	Memory depth options 256 K, 1 M, 4 M, 16 M, 32 M or 64 M
16950B	Memory depth options 1 M, 4 M, 16 M, 32 M or 64 M

**Module differences for the 16950 series modules**

This table lists the key differences for the 16950 series modules. All other specifications and characteristics are the same.

16950 Series module connections:

- You can combine up to five 16951Bs in a multiple-card set. The combined set will have 256 M memory depth across all channels.
- You can combine up to five 16950Bs in a multiple-card set. The combined set will default to the lowest memory depth in the set.
- You can combine any combination of 16753A, 16754A, 16755A, 16756A, and 16950As in a multiple-card set. The combined set will default to the lowest memory depth in the set.

	<b>16951B</b>	<b>16950B</b>	<b>16950A</b>
State speed	667 MHz	667 MHz	600 MHz
Max data rate	667 Mb/s (DDR) 1066 Mb/s (Dual sample)	667 Mb/s (DDR) 1066 Mb/s (Dual sample)	600 Mb/s (DDR) 800 Mb/s (Dual sample)
Memory depth	256 M	1 M to 64 M	256 K to 64 M
Minimum eye width in system under test	550 ps typical	550 ps typical	600 ps typical
Minimum time between active clock edges	1.50 ns (667 Mb/s state mode)	1.50 ns (667 Mb/s state mode)	1.67 ns (600 Mb/s state mode)
Minimum state clock pulse width	1.50 ns	1.50 ns	1.67 ns

## Unleash the complementary power of a logic analyzer and an oscilloscope

Easily make time-correlated measurements between Agilent logic analyzers and oscilloscopes. The time-correlated logic analyzer and oscilloscope waveforms are integrated into a single logic analyzer waveform display for easy viewing and analysis. You can also trigger the oscilloscope from the logic analyzer (or vice versa), automatically de-skew the tracking between the two instruments.

Perform the following more effectively:

- Validate signal integrity
- Track down problems caused by signal integrity
- Validate correct operation of A/D and D/A converters
- Validate correct logical and timing relationships between the analog and digital portions of a design

### View Scope connections and compatibility

Connections	LAN for data transfer, two BNCs for cross triggering
Sample clock synchronization	Oscilloscope 10 MHz Clock BNC to logic analyzer Clock In BNC
Agilent logic analyzer support	16900 Series, 16800 Series, 1690 Series, 1680 Series
Agilent oscilloscope support	DSO80000 Series, Infiniium 8000 Series, Infiniium 54800 Series, 6000 Series bench-top portable

**Table 6. Agilent logic analyzer and oscilloscope compatibility and connections.**

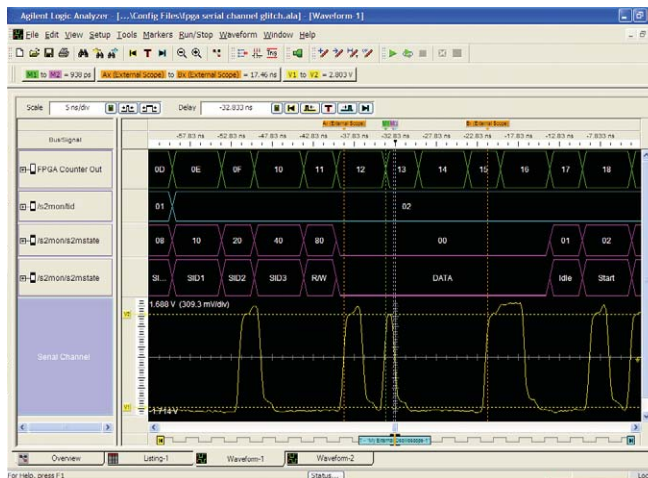

**Figure 6. Make time-correlated measurements between an Agilent logic analyzer and oscilloscope.**

Feature	Benefit
Automated setup	Quickly get to your first measurement using the logic analyzer's help wizard for easy setup, regardless of which supported Agilent oscilloscope you connect to.
Integrated waveform display	Instantly validate the logical and timing relationships between the analog and digital portions of your design. View oscilloscope and logic analyzer waveforms integrated into a single logic analyzer waveform display.
Automatic measurement de-skew	Save time and gain confidence in measurement results with measurements that are automatically de-skewed in time.
Cross trigger the logic analyzer and oscilloscope	Start your debug approach from either the analog or digital domain with the flexibility to trigger the oscilloscope from the logic analyzer (or vice versa).
Tracking markers	Precisely relate information on the oscilloscope's display to the corresponding point in time on the logic analyzer display with tracking markers. The oscilloscope's time markers automatically track adjustments of the logic analyzer's global markers.
Sampling clock synchronization to 10 MHz signal	Maintain measurement accuracy even when viewing the waveforms at long delay settings. Synchronizing the sampling clocks of the logic analyzer and oscilloscope keeps the measurement tightly time-correlated across the entire acquisition.

**Table 5. Key features and benefits of integrating Agilent oscilloscope and logic analyzer capabilities.**

## Optional analysis packages for logic analyzers

---

B4655A FPGA dynamic probe for Xilinx B4656A FPGA dynamic probe for Altera	Gain unprecedented visibility into your Xilinx or Altera FPGA's internal activity. Make incremental real-time measurements in seconds without stopping the FPGA, changing the design or modifying design timing. Quickly set up the logic analyzer's signal bus naming by leveraging work you did in your design environment. <a href="http://www.agilent.com/find/fpga">www.agilent.com/find/fpga</a>
89601A-200 and -300 digital vector signal analysis	Perform time-domain, spectrum, and modulation quality analysis on digital Baseband and IF signals. Both options are required to provide hardware and software connectivity for logic analyzers. <a href="http://www.agilent.com/find/dvsa">www.agilent.com/find/dvsa</a>
B4602A signal extractor tool	Extract and process signals from the logic analyzer data for output onto new buses/signals. Analysis on the new buses/signals can be done within the logic analyzer or by other tools. The tool is suited to: <ul style="list-style-type: none"><li>• Extract I and Q data from serial data streams. The IQ data can be ported directly to the 89601A software for physical layer test and analysis</li><li>• Create algorithms for use with Agilent's N5110B Baseband Studio</li><li>• Re-multiplex high-speed A/D digital data that has been de-multiplexed onto additional logic analyzer channels due to high state speeds</li><li>• Includes sample DigRF algorithms for synchronization of signal extraction to any pattern in the digital stream</li></ul>
B4601C serial-to-parallel analysis package	Eliminate the tedious, time-consuming, and error-prone task of sifting through thousands of analysis package serial bits by looking at long vertical columns of captured 1's and 0's. The B4601C serial-to-parallel analysis package is general-purpose software that allows easy viewing and analysis of serial data. <a href="http://www.agilent.com/find/logic-sw-apps">www.agilent.com/find/logic-sw-apps</a>
B4606A advanced customization environment – development and runtime package	Tailor your logic analyzer interface with a wide range of control, analysis and display capabilities specific to your measurement application. Create integrated dialogs, graphical displays and analysis functions to quickly manipulate measurement data into a format that provides additional insight and answers. <a href="http://www.agilent.com/find/logic-customview">www.agilent.com/find/logic-customview</a>
B4607A advanced customization environment – runtime package	Run the macros and graphical views created with a B4606A development package or obtain and run a variety of commonly requested tools from Agilent and it's partners to help customize your measurement environment.
B4608A ASCII remote programming interface	Remotely control a 16900-, 16800-, 1680-, or 1690-Series logic analysis system by issuing ASCII commands. This interface is designed to be as similar as possible to the RPI on the 16700 Series logic analysis system, so that you can reuse existing programs. Requires either B4606A or B4607A to be enabled. You can also use the B4606A to customize and add RPI commands.
B4610A data import package	Use the logic analyzer GUI to view data obtained from tools other than a logic analyzer.
B4630A MATLAB® connectivity and analysis package	Make an easy connection to MATLAB and transfer your logic analyzer measurement data for processing. Display the results on the logic analyzer in an XY scattergram chart.

---



## Processor, bus and FPGA support

Agilent Technologies and our partners provide an extensive range of bus and processor analysis probes. They provide non-intrusive, full-speed, real-time analysis to accelerate your debugging process.

- Save time making bus- and processor-specific measurements with application specific analysis probes that quickly and reliably connect to your device under test.
- Display processor mnemonics or bus cycle decode.
- Get support for a comprehensive list of industry-standard processors and buses.

Microprocessors/ microcontrollers	FPGAs	I/O buses	Memory buses	Serial buses	Graphics buses
AMD, Analog Devices, ARM, AT&T, Dallas, DEC, Freescale, GTE, IBM, IDT, Infineon, Intel, LSI Logic, McDonnell Douglas, MIPS Motorola, National, NEC, PACE, PMC Sierra/QED, Rockwell, Siemens, Texas Instruments, Toshiba, Zilog	Xilinx: Virtex-5, Virtex 4, Virtex-II Pro series, Virtex-II series, Spartan-3 series  Altera: Stratix II GX, Stratix II, Stratix GX, Stratix, Cyclone II, Cyclone, Max II, APEX 20K, APEX II, Excalibur	PCI, PCI-X®, PCI Express®, Serial ATA (SATA 1 and 2), SCSI, Serial Attached SCSI (SAS), HyperTransport, SPI, SPI 4.2/PL4, Parallel Rapid IO, Serial Rapid IO	DDR1, DDR2, PC-100/133, GDDR3, Fully Buffered DIMM (FB-DIMM), Rambus	Fibre Channel, I <sup>2</sup> C, IEEE-1394, Serial ATA (SATA 1 and 2), USB 2.0/1.1, PCI Express, RS-232, CAN, IEEE-488, SPI, Serial Rapid IO	AGP2x, AGP4x, AGP3.0, PCI Express

## 16900 Series mainframes characteristics

### Data displays

Waveform	Integrated display of data as digital waveforms, analog waveforms, imported from an external oscilloscope, and/or as a chart of a bus' values over time.
Listing	Displays data as a state listing.
Packet Viewer	Displays summarized and detailed packet information simultaneously within two panes. The window is automatically customized for the protocol family being decoded. The upper packet summary pane displays decoded packets and fields. The lower pane contains tabs for viewing selected packet details, header, payload, and lane information.
VBA View	The VbaView window works with the integrated Microsoft Visual Basic for Applications (VBA) to provide custom data visualization charts.
Compare	Compares data from different acquisitions and highlights differences.
Source code	<p>Displays time-correlated source code and inverse assembly simultaneously in a split display.</p> <p>Define the trigger event by simply clicking on a line of source code.</p> <p>Obtain source-code-level views of dynamically loaded software or code moved from ROM to RAM during a boot-up sequence using address offsets.</p> <p>Requires access to source files via the LAN or instrument hard drive to provide source code correlation.</p> <p>Source correlation does not require any modification or recompilation of your source code.</p>
Eye Scan	Displays eye diagrams across all buses and signals simultaneously, allowing you to identify problem signals quickly.

### Numeric bases for data display

Binary, hex, octal, decimal, signed decimal (two's complement), ASCII, symbols, and processor mnemonics

### Symbolic support/object file format compatibility

Number of symbols/ranges — Unlimited (limited only by amount of virtual memory available on 16900 Series mainframes)

IEEE-695, Aout, Omf86, Omf96, Omf386, Sysrof, ELF/DWARF1,\* ELF/DWARF2\*, ELF/Stabs1, ELF/Stabs2, ELF/Mdebug Stabs, TICOFF/COFF, TICOFF/Stabs

GPA (General Purpose ASCII)

User defined — specify a mnemonic for a given bit pattern for a label or bus

\* Supports C++ name de-mangling

## 16900 Series mainframes characteristics

### Available configuration data/file formats

ala	Contains information to reconstruct the display appearance, instrument settings, and trace data (optional) that were present when the file was created.
xml	Extensible markup language for configuration portability and programmability.

### Available data import/export data/file formats

csv	CSV (comma-separated values) format for transferring data to other applications like Excel.
alb	Export logic analyzer data for post-processing. Alb data can be parsed using programming tools.

### Standard analysis tools

Filter/colorize
Find (next/previous)

## Programmability

You can write programs to control the logic analyzer application from remote computers on the local area network using COM or ASCII.

The COM automation server is part of the logic analyzer application. This software allows you to write programs to control the logic analyzer. All measurement functionality is controllable via the COM interface.

The B4608A Remote Programming Interface (RPI) lets you remotely control a 16900-Series logic analysis system by issuing ASCII commands to the TCP socket on port 6500. This interface is designed to be as similar as possible to the RPI on 16700-Series logic analysis sys-

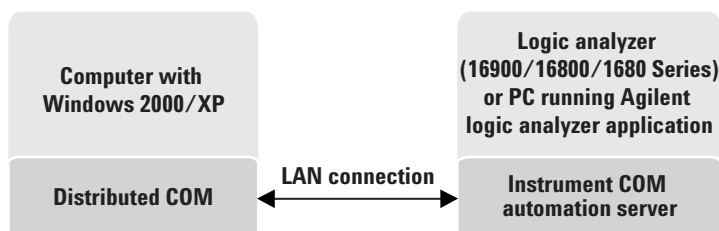

Figure 7. 16900 Series programming overview

tems, so that you can reuse existing programs. The B4608A requires the Advanced Customization Environment Development (B4606A) or Runtime (B4607A) package to operate.

The Remote Programming Interface works through the COM automation objects, methods, and

properties provided for controlling the logic analyzer application. RPI commands are implemented as Visual Basic modules that execute COM automation commands, translate their results, and return proper values for the RPI. You can use the B4606A Advanced Customization Environment to customize and add RPI commands.

# 16901A Instrument Characteristics

## 16901A PC characteristics

---

Operating system	Microsoft Windows® XP Professional
Processor	Intel Celeron™ 2.93 GHz
Chipset	Intel 915G
System memory	1 GB SDRAM
Hard disk drive	80 GB (or higher)
Installed on hard drive	Operating system, latest revision of the logic analyzer application software, optional application software ordered with the logic analyzer

---

## 16901A instrument controls

---

LCD display	Large 38.1-cm (15-in.) display makes is easy to view a large number of waveforms or states
Front-panel hot keys	Dedicated hot keys for selecting run mode and disabling touch screen
Front-panel knob	General-purpose knob adjusts viewing and measurement parameters
Keyboard and mouse	PS/2 keyboard and mouse (shipped standard)

---

## 16901A video display modes

---

Touch-screen display	Size	38.1 cm (15 in.) diagonal
	Resolution	1024 x 768
External display	Simultaneous display capability	Front panel and external display can be used simultaneously at 1024 x 768 resolution
		Supports up to four external monitors at up to 1600x1200 (with PCI video card)

---

# 16901A Interfaces

## Peripheral interfaces

---

Display	15-pin VGA connector
Keyboard	PS/2
Mouse	PS/2
Parallel	25-pin D-sub
Serial	9-pin D-sub
PCI card expansion slot	1 full profile
USB	Six 2.0 ports, two in front, four in rear

---

## Connectivity interfaces

---

LAN	10/100 Mb/s
Connector	RJ-45

---

## Interface with external instrumentation

Trigger or arm external devices or receive signals that can be used to arm measurement hardware within the logic analyzer with Trigger In/Out

---

Trigger In	
Input	Rising edge or falling edge
Action taken	When received, the logic analyzer takes the actions described in the trigger sequence step
Input signal level	$\pm 5$ V max
Threshold level	Selectable: ECL, LVPECL, LVTTTL, PECL, TTL User defined ( $\pm 5$ V in 50 mV increments)
Minimum signal amplitude	200 mV
Connector	BNC
Input resistance	4 k ohm nominal

---

Trigger Out	
Trigger	Rising edge or falling edge. OR of selected events that cause Trigger Out (logic analyzer trigger or flags)
Output signal	$V_{OH}$ (output high level) 2.0 V min $V_{OL}$ (output low level) 0.5 V max Pulse width approx. 80-160 ns
Threshold level	LVTTTL (3.3 V logic)
Signal load	50 ohm (For good signal quality, the trigger out signal should be terminated in 50 ohms to ground)
Connector	BNC

---

# 16901A Physical Characteristics

## Dimensions

### Power

115/230 V, 48-66 Hz, 775 W max

Weight*	Max net	Max shipping
16901A	13.6 kg (30 lbs)	20.4 kg (45 lbs)

\* Weight of modules ordered with mainframe will add 0.9 kg (2.0 lb per module)

### Instrument operating environment

Temperature	0°C to 45°C (32°F to 113°F)
Altitude	To 3000 m (10,000 ft)
Humidity	8 to 80% relative humidity at 40°C (104°F)

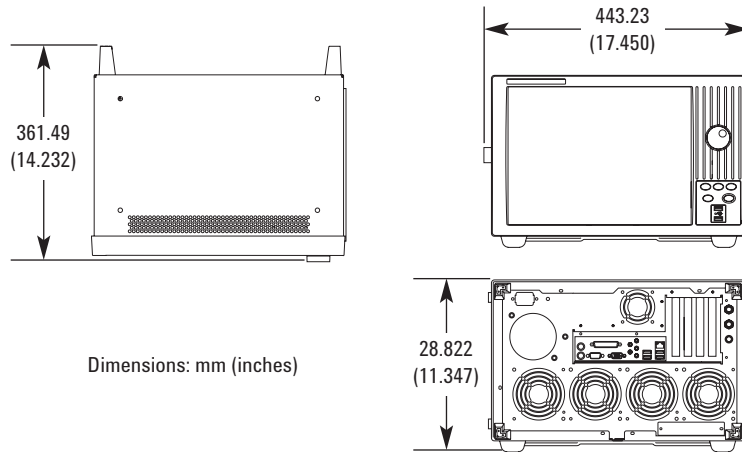

Figure 8. 16901A exterior dimensions

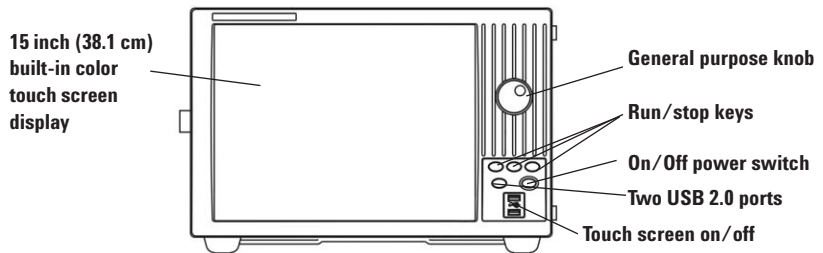

Figure 9. 16901A front panel

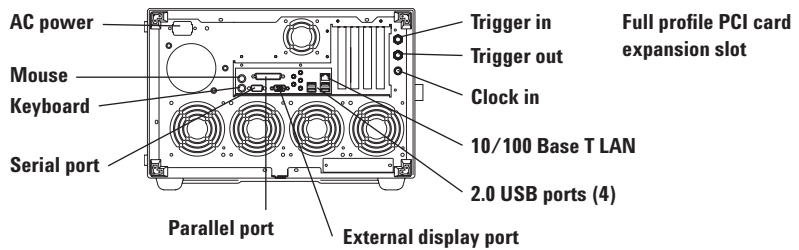

Figure 10. 16901A back panel

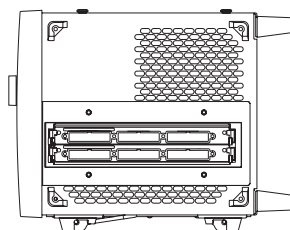

Figure 11. 16901A side view

**16900A, 16902A and 16903A Series  
PC characteristics**

Operating system	Microsoft Windows XP Professional
Processor	Intel Pentium® III
Chipset	Intel 815E
System memory	512 MB PC 133 SDRAM max
CD ROM	24x CD-R writing, 24x CD-RW writing, 8x CD ROM reading
Hard disk drive	80 GB
Installed on hard drive	Operating system, latest revision of the logic analyzer application software, optional application software ordered with the mainframe

**16900A, 16902A and 16903A Series  
instrument controls**

Touch-screen LCD display (16902A and 16903A)	Large 30.7-cm (12.1-in.) display makes is easy to view a large number of waveforms or states.
Front-panel hot keys (16902A and 16903A)	Dedicated hot keys give instant access to the most frequently used menus, displays, and on-line help.
Front-panel knobs (16902A and 16903A)	Dedicated knobs for horizontal and vertical scaling and scrolling
Keyboard and mouse	PS/2 keyboard and mouse (shipped standard)

**16902A and 16903A Series  
video display modes**

<b>Built-in touch-screen display (16902A and 16903A)</b>	
Size	30.7 cm (12.1 in.) diagonal
Resolution	800 x 600
Simultaneous display capability	Front panel and external display can be used simultaneously at 800 x 600 resolution.
<b>External display</b>	Supports up to four external monitors at up to 1600x1200 (with PCI video card)

## 16900A, 16902A and 16903A interfaces

### Peripheral interfaces

Display	15-pin VGA connector
Keyboard	PS/2
Mouse	PS/2
Parallel	25-pin D-sub
Serial	9-pin D-sub
PCI card expansion slots	1 full profile and 1 low profile
USB	Two 1.1 ports

### Connectivity interfaces

LAN	10/100Mb/s, Gbit (optional)
Connector	RJ-45

### Interface with external instrumentation

Trigger or arm external devices or receive signals that can be used to arm measurement modules within the logic analyzer with Trigger In/Out.

#### Trigger In

Input	Rising edge or falling edge
Action taken	When received, the logic analyzer takes the actions described in the trigger sequence step.
Input signal level	$\pm 5$ V max
Threshold level	Selectable: ECL, LVPECL, LVTTTL, PECL, TTL User defined ( $\pm 5$ V in 50 mV increments)
Minimum signal amplitude	200 mV
Connector	BNC
Input resistance	4 k ohm nominal

#### Trigger Out

Trigger	Rising edge or falling edge. OR of selected events that cause Trigger Out (module trigger or flags)
Output signal	$V_{OH}$ (output high level) 2.0 V min $V_{OL}$ (output low level) 0.5 V max Pulse width approx. 80-160 ns
Threshold level	LVTTTL (3.3 V logic)
Signal load	50 ohm (For good signal quality, the trigger out signal should be terminated in 50 ohms to ground)
Connector	BNC

### Remote control or your device under test

Conveniently control your target remotely by using the target control port to activate reset or interrupt lines.

#### Target control port

Number of signals	8
Output Disabled	Tri-state, high-impedance
Output Enabled	TTL level with 1 high, 0 low
Toggle	Flips the setting of the signal. If the signal is set to 1, Toggle changes the signal to 0.
Pulse	Flips the signal setting for one clock cycle which is at least 16 ms. The pulse duration cannot be specified.
Levels	3.3 V (LVTTTL) compatible
Connector	2 rows of 5 pins, 0.1-inch centers



## 16900A, 16902A and 16903A physical characteristics

### Dimensions

#### Power

16900A	115/230 V, 48 to 66 Hz, 1300 W max
16902A	115/230 V, 48 to 66 Hz, 1300 W max
16903A	115/230 V, 48 to 66 Hz, 900 W max

#### Weight\*

	Max Net	Max Shipping
16900A	16 kg (35.2 lbs)	24.6 kg (54.2 lbs)
16902A	17.2 kg (37.8 lbs)	25.8 kg (56.8 lbs)
16903A	14.5 kg (32.0 lbs)	23.2 kg (51.0 lbs)

\* Weight of modules ordered with mainframes will add 0.9 kg (2.0 lb per module)

### Instrument operating environment

Temperature	<ul style="list-style-type: none"> <li>• 0° C to 50° C (32° F to 122° F) for 16903A</li> <li>• 0° C to 40° C (32° F to 104° F) for 16900A and 16902A</li> </ul>
Altitude	To 3000m (10,000 ft)
Humidity	8 to 80% relative humidity at 40° C (104° F)

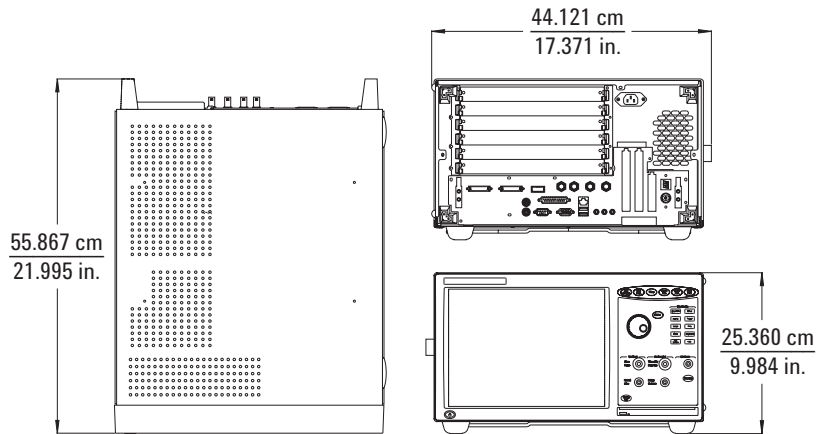

Figure 12. 16900A/16902A/16903A exterior dimensions

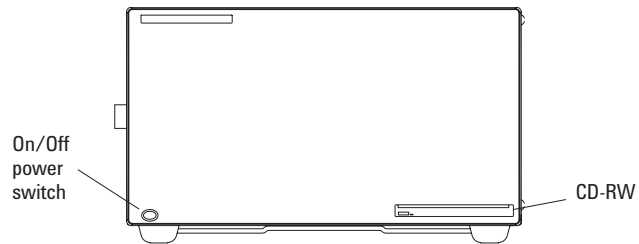

Figure 13. Agilent 16900A front panel

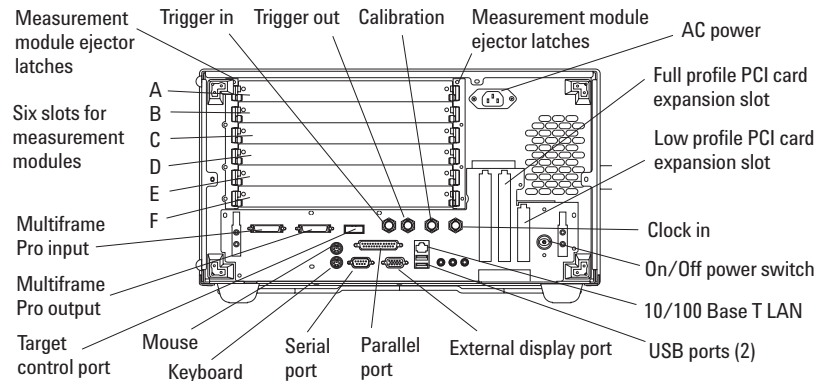
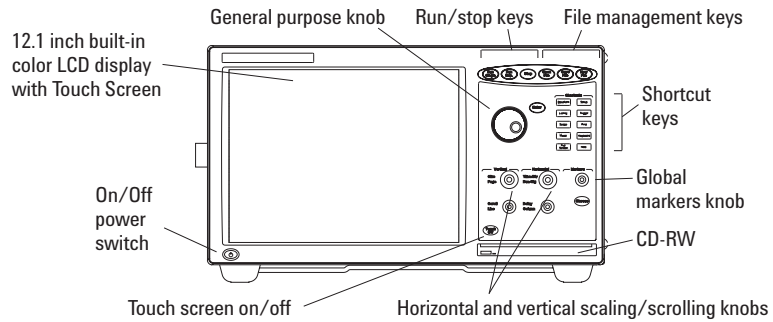

Figure 14. Agilent 16900A back panel

**16900A, 16902A and 16903A  
physical characteristics**

**Dimensions, continued**



**Figure 15. Agilent 16902A front panel**

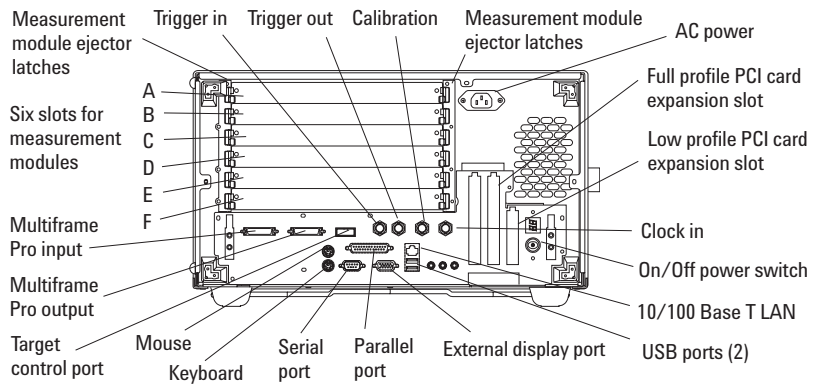

**Figure 16. Agilent 16902A back panel**

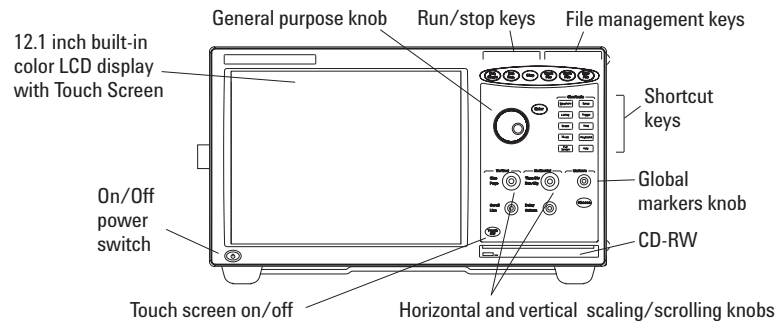

**Figure 17. Agilent 16903A front panel**

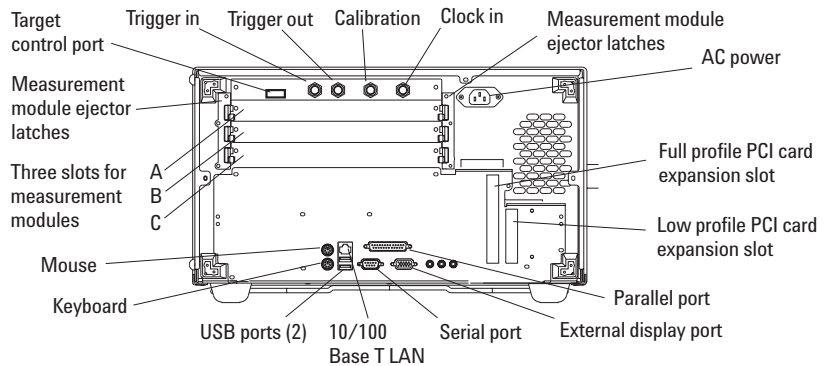

**Figure 18. Agilent 16903A back panel**

## Agilent 1184A Testmobile

The Agilent 1184A testmobile gives you a convenient means of organizing and transporting your logic analysis system mainframes and accessories.

The testmobile includes the following:

- Drawer for accessories (probes, cables, power cords)
- Keyboard tray with adjustable tilt and height
- Mouse extension on keyboard tray for either right or left hand operation
- Locking casters for stability on uneven surfaces
- Strap to stabilize the monitor
- Load limits: Top tray: 68.2 kg (150.0 lb.) Lower tray: 68.2 kg (150.0 lb.) Total: 136.4 kg (300.0 lb.)



Figure 19. Agilent 1184A testmobile cart.

### Weight

	Max Net	Max Shipping
1184A	48.0 kg (106.0 lb)	59.0 kg (130.0 lbs)

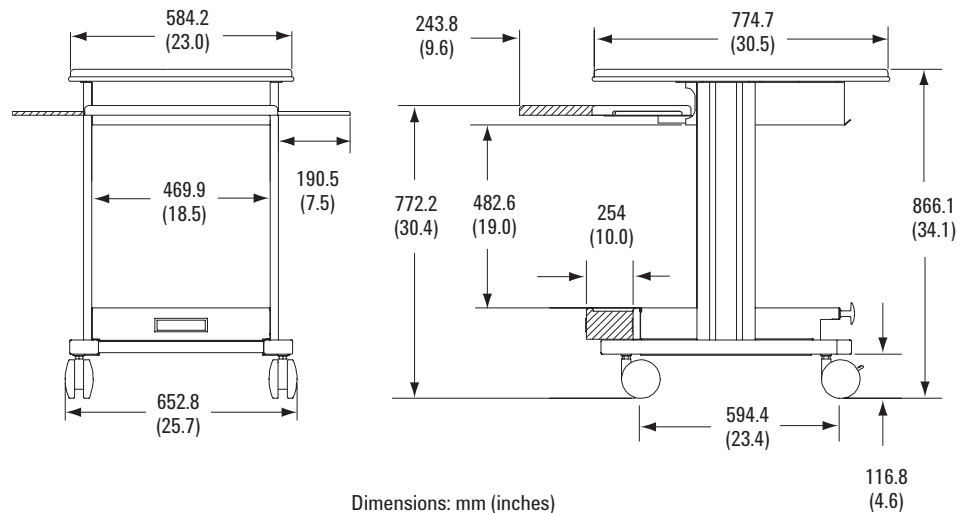
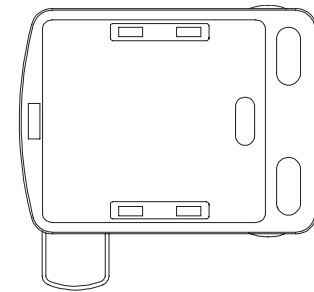

Figure 20. Agilent 1184A testmobile cart dimensions.

## Rack Accessories



Figure 21. Sliding shelf installed in rack

### Stationary Shelf

This light-duty fixed shelf is designed to support the 16900 series frames. The shelf can be used in all standard Agilent racks. The stationary shelf is mounted securely into place using the supplied hardware and is designed to sit at the bottom of the EIA increment. Features of the stationary shelf include:

- Snap-in design for easy installation
- Smooth edges

### Sliding Shelf

The sliding shelf provides a flat surface with full product accessibility. It can be used in all Agilent racks to support the 16900 series logic analysis systems. The shelf and slides are preassembled for easy installation. Features of the sliding shelf include:

- Snap-in design for easy installation
- Smooth edges

Consider purchasing the steel ballast (C2790AC) to use with the sliding shelf. The ballast provides anti-tip capability when the shelf is extended.

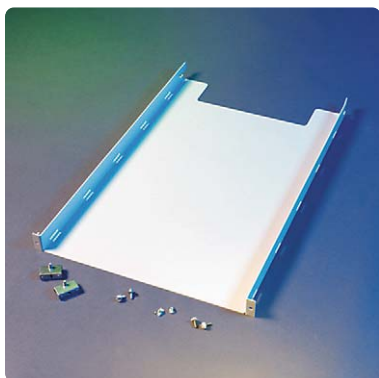

Figure 22. Stationary shelf (J1520AC)

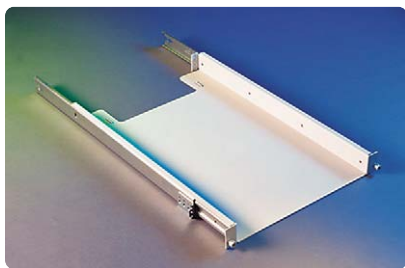

Figure 23. Sliding shelf (J1526AC)

## Specifications

	J1520AC	J1526AC
Material	Cold-rolled steel	Cold-rolled steel
Weight	8 kg (17.6 lbs)	9.9 kg (22 lbs)
Color	Quartz gray	Quartz gray
Length	678 mm (26.7 in)	723.9 mm (28.5 in)
Height	44 mm (1.73 in)	44.5 mm (1.75 in)
Width	444 mm (17.5 in)	482.6 mm (19 in)
Load Capacity	68 kg (150 lbs)	Capacity 68 kg (150 lbs)
Contains	1 stationary shelf 2 rear brackets Mounting hardware	1 sliding shelf 2 rear brackets 1 cable strap Mounting hardware

## Ordering Information

Agilent product number	Description
16900A	6-Slot Logic Analysis System Mainframe
16901A	2-Slot Logic Analysis System Mainframe with Built-in 15" (38.1 cm) Touch Display
16902A	6-Slot Logic Analysis System Mainframe with Built-in Touch Display
16903A	3-Slot Logic Analysis System Mainframe with Built-in Touch Display

Each frame comes with one PS/2 keyboard, one PS/2 mouse, and 1-year warranty standard. The 16900A, 16902A and 16903A also come with one ten conductor flying lead cable for the target control port.

Agilent product number or option number	Description	Ordering info
16900A-014 16902A-014 16903A-014	Gbit LAN card (low profile, copper connection)	Installed in mainframe. Must be ordered at time of mainframe purchase
E5860A	Gbit LAN card (low profile, copper connection)	Order for existing 16900A, 16902A, or 16903A frames. Customer installable.
E5861A	Multiframe cable cable length	Order 1 less than the number of mainframes to be connected together

## Related literature

Publication title	Publication type	Publication number
<i>Agilent Technologies Timing and State Modules for the 16900 Series Logic Analysis System</i>	Data Sheet	5989-0422EN
<i>Agilent Technologies 16800 Series Portable Logic Analyzers</i>	Brochure	5989-5062EN
<i>Agilent Technologies 16800 Series Portable Logic Analyzers</i>	Data Sheet	5989-5063EN
<i>Agilent Technologies FPGA Dynamic Probe for Xilinx</i>	Data Sheet	5989-0423EN
<i>Agilent Technologies FPGA Dynamic Probe for Altera</i>	Data Sheet	5989-5595EN
<i>Probing Solutions for Agilent Technologies Logic Analyzers</i>	Catalog	5968-4632E
<i>Application Support for Agilent Logic Analyzers</i>	Configuration Guide	5966-4365E
<i>Innovative Digital Debug Solutions CD with Videos</i>	CD-ROM	5980-0941EN

For copies of this literature, contact your Agilent representative or visit [www.agilent.com/find/logic](http://www.agilent.com/find/logic)



### Agilent Email Updates

[www.agilent.com/find/emailupdates](http://www.agilent.com/find/emailupdates)

Get the latest information on the products and applications you select.



### Agilent Direct

[www.agilent.com/find/quick](http://www.agilent.com/find/quick)

Quickly choose and use your test equipment solutions with confidence.



[www.agilent.com/find/open](http://www.agilent.com/find/open)

Agilent Open simplifies the process of connecting and programming test systems to help engineers design, validate and manufacture electronic products. Agilent offers open connectivity for a broad range of system-ready instruments, open industry software, PC-standard I/O and global support, which are combined to more easily integrate test system development.

Microsoft and Windows are U.S. registered trademarks of Microsoft Corporation.

Pentium is a U.S. registered trademark of Intel Corporation.

MATLAB® is a U.S. registered trademark of The MathWorks, Inc.

PCI-X and PCI Express are registered trademarks of PCI-SIG.

## Remove all doubt

Our repair and calibration services will get your equipment back to you, performing like new, when promised. You will get full value out of your Agilent equipment throughout its lifetime. Your equipment will be serviced by Agilent-trained technicians using the latest factory calibration procedures, automated repair diagnostics and genuine parts. You will always have the utmost confidence in your measurements.

Agilent offers a wide range of additional expert test and measurement services for your equipment, including initial start-up assistance onsite education and training, as well as design, system integration, and project management.

For more information on repair and calibration services, go to

[www.agilent.com/find/removealldoubt](http://www.agilent.com/find/removealldoubt)

## [www.agilent.com](http://www.agilent.com)

For more information on Agilent Technologies' products, applications or services, please contact your local Agilent office. The complete list is available at:

[www.agilent.com/find/contactus](http://www.agilent.com/find/contactus)

### Phone or Fax

#### United States:

(tel) 800 829 4444  
(fax) 800 829 4433

#### Canada:

(tel) 877 894 4414  
(fax) 800 746 4866

#### China:

(tel) 800 810 0189  
(fax) 800 820 2816

#### Europe:

(tel) 31 20 547 2111

#### Japan:

(tel) (81) 426 56 7832  
(fax) (81) 426 56 7840

#### Korea:

(tel) (080) 769 0800  
(fax) (080) 769 0900

#### Latin America:

(tel) (305) 269 7500

#### Taiwan:

(tel) 0800 047 866  
(fax) 0800 286 331

#### Other Asia Pacific Countries:

(tel) (65) 6375 8100  
(fax) (65) 6755 0042  
Email: [tm\\_ap@agilent.com](mailto:tm_ap@agilent.com)

Revised: 09/14/06

Product specifications and descriptions in this document subject to change without notice.

© Agilent Technologies, Inc. 2007  
Printed in USA, November 1, 2007  
5989-7584EN



Agilent Technologies