

## Errata

**Title & Document Type:** 8158B Optical Attenuator Operating and Programming Manual

**Manual Part Number:** 08158-90012

**Revision Date:** February 1987

---

### HP References in this Manual

This manual may contain references to HP or Hewlett-Packard. Please note that Hewlett-Packard's former test and measurement, semiconductor products and chemical analysis businesses are now part of Agilent Technologies. We have made no changes to this manual copy. The HP XXXX referred to in this document is now the Agilent XXXX. For example, model number HP8648A is now model number Agilent 8648A.

### About this Manual

We've added this manual to the Agilent website in an effort to help you support your product. This manual provides the best information we could find. It may be incomplete or contain dated information, and the scan quality may not be ideal. If we find a better copy in the future, we will add it to the Agilent website.

### Support for Your Product

Agilent no longer sells or supports this product. You will find any other available product information on the Agilent Test & Measurement website:

[www.tm.agilent.com](http://www.tm.agilent.com)

Search for the model number of this product, and the resulting product page will guide you to any available information. Our service centers may be able to perform calibration if no repair parts are needed, but no other support from Agilent is available.

# OPERATING AND PROGRAMMING MANUAL

## HP8158B OPTICAL ATTENUATOR

OPTION 001 850nm

OPTION 002 1300/1550nm

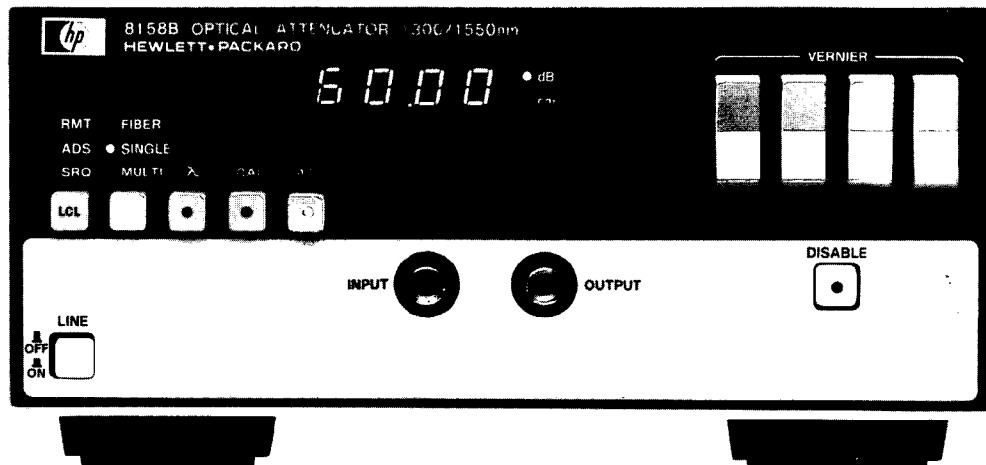

Photo shows option 002.

# **OPERATING AND PROGRAMMING MANUAL**

## **HP8158B OPTICAL ATTENUATOR**

**OPTION 001 850nm**

**OPTION 002 1300/1550nm**

### **SERIAL NUMBERS**

This manual applies directly to instruments with serial number 2646G00286 and higher for option 001 and serial number 2606G00101 and higher for option 002. Any change made in instruments having serial numbers higher than the above numbers will be found in a "Manual Changes" supplement supplied with this manual. Be sure to examine the supplement for changes which apply to your instrument and record these changes in the manual.

**© HEWLETT-PACKARD GMBH 1986  
HERRENBERGER STR. 130, D-7030 BOBLINGEN  
FEDERAL REPUBLIC OF GERMANY**

## SAFETY SUMMARY

The following general safety precautions must be observed during all phases of operation, service, and repair of this instrument. Failure to comply with these precautions or with specific warnings elsewhere in this manual violates safety standards of design, manufacture, and intended use of the instrument. Hewlett-Packard Company assumes no liability for the customer's failure to comply with these requirements.

**GENERAL** — This is a Safety Class I instrument (provided with terminal for protective earthing) and has been manufactured and tested according to international safety standards.

**OPERATION — BEFORE APPLYING POWER** comply with the installation section. Additionally, the following shall be observed:

Do not remove instrument covers when operating.

Before the instrument is switched on, all protective earth terminals, extension cords, auto-transformers and devices connected to it should be connected to a protective earth via a ground socket. Any interruption of the protective earth grounding will cause a potential shock hazard that could result in serious personal injury. Whenever it is likely that the protection has been impaired, the instrument must be made inoperative and be secured against any unintended operation.

Make sure that only fuses with the required rated current and of the specified type (normal blow, time delay, etc.) are used for replacement. The use of repaired fuses and the short-circuiting of fuseholders must be avoided.

Adjustments described in the manual are performed with power supplied to the instrument while protective covers are removed. Energy available at many points may, if contacted, result in personal injury.

Any adjustment, maintenance, and repair of the opened instrument under voltage should be avoided as much as possible, and when inevitable, should be carried out only by a skilled person who is aware of the hazard involved. Do not attempt internal service or adjustment unless another person, capable of rendering first aid and resuscitation is present. Do not replace components with power cable connected.

Do not operate the instrument in the presence of flammable gases or fumes. Operation of any electrical instrument in such an environment constitutes a definite safety hazard.

Do not install substitute parts or perform any unauthorized modification to the instrument.

Capacitors inside the instrument may still be charged even if the instrument has been disconnected from its source of supply.

### SAFETY SYMBOLS



The apparatus will be marked with this symbol when it is necessary for the user to refer to the instruction manual in order to protect the apparatus against damage.



Indicates dangerous voltages.



Earth terminal

**WARNING**

The **WARNING** sign denotes a hazard. It calls attention to a procedure, practice or the like which, if not correctly performed or adhered to, could result in injury or loss of life. Do not proceed beyond a **WARNING** sign until the indicated conditions are fully understood and met.

**CAUTION**

The **CAUTION** sign denotes a hazard. It calls attention to an operating procedure, practice, or the like, which, if not correctly performed or adhered to, could result in damage to or destruction of part or all of the equipment. Do not proceed beyond a **CAUTION** sign until the indicated conditions are fully understood and met.



Dangerous voltages, capable of causing serious personal injury, are present in this instrument. Use extreme caution when handling, testing, and adjusting.

# CONTENTS

SECTION		Page
<b>1</b>	<b>GENERAL INFORMATION</b>	
1.1	INTRODUCTION	1-1
1.2	SPECIFICATIONS	1-1
1.3	SAFETY CONSIDERATIONS	1-1
1.4	INSTRUMENTS COVERED BY THIS MANUAL	1-1
1.5	DESCRIPTION	1-1
1.6	ACCESSORIES SUPPLIED	1-2
1.7	ACCESSORIES AVAILABLE	1-2
<b>2</b>	<b>INSTALLATION</b>	
2.1	INTRODUCTION	2-1
2.2	INITIAL INSPECTION	2-1
2.3	PREPARATION FOR USE	2-1
2.4	Power Requirements	2-1
2.5	Line Voltage Selection	2-1
2.6	Power Cable	2-2
2.7	HP-IB Connector	2-3
2.8	HP-IB Logic Levels	2-3
2.9	OPERATING ENVIRONMENT	2-4
2.10	CLAIMS AND REPACKAGING	2-4
2.11	STORAGE AND SHIPMENT	2-4
<b>3</b>	<b>OPERATING AND PROGRAMMING</b>	
3.1	INTRODUCTION	3-1
3.2	SPECIAL OPERATING CONSIDERATIONS	3-1
3.3	OPERATORS CHECKS	3-1
3.4	GETTING TO KNOW YOUR INSTRUMENT	3-2
3.5	SETTING THE ATTENUATION	3-3
3.6	Basic Considerations	3-3
3.7	Optimize the Display With the CAL Key	3-4
3.8	PROGRAMMING	3-5
3.9	WHAT YOU NEED TO KNOW ...	3-5
3.10	... About The HP8158B's HP-IB Capabilities	3-5
3.11	... About Programming Examples in This Section	3-5
3.12	GETTING STARTED	3-6
3.13	Setting The Address	3-6
3.14	Checking Remote Operation	3-6
3.15	SENDING DATA TO THE HP8158B (LISTENER FUNCTION)	3-6
3.16	RECEIVING DATA FROM THE HP8158B (TALKER FUNCTION)	3-7
3.17	STATUS/ERROR REPORTING (TALKER FUNCTION)	3-8
3.18	Status Register and Status Byte	3-8
3.19	Setting The SRQ Mask	3-10
3.20	Condition Register	3-10
	COMMAND SUMMARY	3-11

## CONTENTS (CONTD)

SECTION		Page
<b>4</b>	<b>PERFORMANCE TESTS</b>	
4.1	INTRODUCTION	4-1
4.2	EQUIPMENT REQUIRED	4-1
4.3	TEST RECORD	4-2
4.4	TEST FAILURE	4-2
4.5	INSTRUMENT SPECIFICATIONS	4-2
4.6	PERFORMANCE TESTS	4-2
4.7	Total Insertion Loss, Attenuation Accuracy and Attenuation Repeatability	4-3
4.8	Total Insertion Loss Test	4-4
4.9	Attenuation Accuracy	4-5
4.10	Attenuator Repeatability	4-6

## TABLES

TABLE		Page
1-1	SPECIFICATIONS	1-3
3-1	HP-IB CAPABILITIES	3-5
4-1	RECOMMENDED TEST EQUIPMENT PERFORMANCE TEST RECORDS	4-1 4-7

## FIGURES

FIGURE		Page
2-1	LINE VOLTAGE SWITCH ASSEMBLY	2-2
2-2	POWER CABLES-PLUG IDENTIFICATION	2-3
2-3	HP-IB CONNECTOR	2-4
3-1	FRONT AND REAR PANELS	3-0
3-2	TYPICAL SETUP	3-4
4-1	TEST SETUP FOR REFERENCE MEASUREMENT	4-4
4-2	TEST SETUP FOR TOTAL INSERTION LOSS	4-4
4-3	TEST SETUP FOR ATTENUATION ACCURACY	4-5

# SECTION I

## GENERAL INFORMATION

### 1.1 INTRODUCTION

This manual contains the information required to install, test, and operate the Hewlett-Packard Model HP8158B Optical Attenuator. The manual is valid for both the options available in this series.

Opt 001	-	600nm - 1200nm
Opt 002	-	1200nm - 1650nm

### 1.2 SPECIFICATIONS

Specifications of the Model HP8158B are given in Table 1-1. These specifications are the performance standards or limits against which the instrument is tested. The specifications are measured with Diamond® HMS-10/HP (Opt.011) and DIN 47256 (Opt.013) connectors. For the specifications to be valid for the DIN 47256 connectors, Siemens and Diamond® DIN connectors should be used for multimode, and Diamond® for single-mode. FC/PC (Opt.012) and ST (Opt.014) connectors should only be used in multimode and the specifications given for the Diamond® HMS-10/HP connector should be taken as typical specifications for these options.

### 1.3 SAFETY CONSIDERATIONS

The Model HP8158B is a Safety Class 1 instrument (instrument with an exposed metal chassis that is directly connected to earth via the power supply cable). The symbol used to indicate a protective earth terminal in the instrument is Ⓢ.

Before operation, the instrument and manual, including the red safety page, should be reviewed for safety markings and instructions. These must then be followed to ensure safe operation and to maintain the instrument in safe condition.

### 1.4 INSTRUMENTS COVERED BY THIS MANUAL

Each Model HP8158B has a two-part serial number. The first 4 digits and the letter comprise the serial number prefix; the last 5 digits a sequential suffix which is unique to each Model HP8158B. The contents of this manual apply directly to optical attenuators having serial numbers above 2646G00286 for opt. 001 and 2606G00101 for opt. 002.

### 1.5 DESCRIPTION

The HP8158B Optical Attenuator option 001 is precisely calibrated at 850nm, the HP8158B option 002 at 1300nm and 1550nm, for the 60dB attenuation range. Because of the advanced optical system, including the lens design and coating, the attenuation can be easily corrected for other wavelengths in the respective ranges by simple entry of the desired wavelength into the instrument memory. This enables you to match the attenuator exactly to the center wavelength of your source, thus ensuring reliable measurement results. The following lists the features of the HP8158B Optical Attenuator:

**Model HP8158B  
General Information**

- designed for single- and multimode fibers with  $NA < 0.3$
- full HP-IB programmability
- 60dB attenuation range
- 0.01dB resolution and 0.04dB repeatability
- correction of attenuation between 600nm and 1200nm for opt 001, and between 1200nm and 1650nm for opt 002

### **1.6 ACCESSORIES SUPPLIED**

The Model HP8158B is supplied complete with the following accessories:

Item	HP Part No.
800 mA Fuse slow-blow (100/120V)*	2110-0020
400 mA Fuse slow-blow (220/240V)*	2110-0340
Power Cord	see Figure 2-2

\* one fitted and one supplied

### **1.7 ACCESSORIES AVAILABLE**

A number of interface cables are available for simplifying connection of the Model HP8158B to various optical signal sources and receivers. For a list of these adapter cables and connectors, see the latest Ordering Guide. The following lists the company options available for the HP8158B:

Option 907	Front Handle Kit
Option 908	Rack Flange Kit
Option 916	Additional Operating and Programming Manual
P/N 5061-9071	Bail Handle Kit

An additional accessory for the Model HP8158B is the HP15475A Cleaning Kit. This kit includes cleaning material (brush, tissue, tape, etc.) to clean optical surfaces such as connectors and is supplied in a plastic carrying case.

### **NOTE**

*If the DIN connector, Opt.013, is used, make sure that the connection between the attenuator and the cable is fully secure as the connector only has a short guiding key. If the connection is not correct then the attenuator will not work to the specifications given.*



**Model HP8158B  
General Information**

**Table 1-1. Specifications**

Specifications describe the instrument's warranted performance. They are measured with Diamond<sup>®</sup> HMS-10/HP and DIN 47256 connectors. For the specifications to be valid for the DIN 47256 connectors, Siemens and Diamond<sup>®</sup> connectors should be used for multimode and Diamond<sup>®</sup> for single-mode.

**Optical Characteristics**

Specifications are measured at 850nm (opt 001) or at 1300nm and 1550nm (opt 002), using a CW laser diode source with constant output power and fibers with 50/125  $\mu\text{m}$  (NA=0.2, GI for Opts.001 and 002) and 9/125  $\mu\text{m}$  (NA=0.1 for Opt.002).

**Wavelength Range:**

opt 001: 600nm to 1200nm

opt 002: 1200nm to 1650nm

**Connector Type:** Diamond<sup>®</sup> HMS-10/HP and DIN 47256

**Applicable Fiber Type:** all fiber types with  $\text{NA} \leq 0.3$

**Attenuation Range (excl. insertion loss):** 60.00dB

**Insertion loss (incl. both connectors)**

	HMS-10/HP		DIN 47256	
	single-mode 9 $\mu\text{m}$	multimode 50 $\mu\text{m}$	single-mode 9 $\mu\text{m}$	multimode 50 $\mu\text{m}$
worst case	< 4.0dB	< 2.0dB	< 5.0dB	< 2.0dB
typical	2.0dB	1.0dB	2.5dB	1.0dB

**Accuracy (Linearity):**

multimode: <  $\pm 0.2\text{dB}$

single-mode: <  $\pm 0.4\text{dB}$

**Repeatability (of attenuation after any parameter has been changed and reset):** <  $\pm 0.04\text{dB}$

**Display**

Display Range: 0.00 to 64.00dB

Display Resolution: 0.01dB (min. step size)

**Supplementary Performance Characteristics**

(Description of non-warranted typical performance parameters)

**Repeatability (of attenuation after a max. of 6 matings of same connector):**

single-mode (9  $\mu\text{m}$ ): <0.2dB

multimode (50  $\mu\text{m}$ ): <0.1dB

**Return Loss (excl. connector):** > 27dB

**Model HP8158B  
General Information**

**Operating Modes**

Output disable: Optical signal path interrupted.

Single: Instrument matched to single-mode fiber. (Opt.002 only)

Multi: Instrument matched to multimode fiber.

$\lambda$ : Entry of wavelength for automatic correction of attenuation using typical correction values

Att: Attenuation is displayed and can be varied

Cal: Entry of calibration factor to adjust display so that displayed value indicates actual power level at output connector of attenuator. Range:  $\pm 99.99$ dB

**General**

Recalibration period: 1 year

No warm-up time required if previously stored within operating temperature range.

**HP-IB Capability**

All modes and parameters can be programmed.

**Listen** (time for HP8158B to receive, verify and execute a message).

Output disable/enable, attenuation,  $\lambda$ : < 20 to 400ms (depending on actual setting/programmed parameter)

Cal: < 5ms

**Talk** (time for HP8158B to transmit a message).

Query commands: < 1ms/character

**HP-IB Interface Function Code:** SH1, AH1, T6, L4, SR1, RL1, PP0, DC1, DT0, C0

**Environmental**

Storage temperature: -40°C to +75°C

Operating temperature: 0°C to +55°C

Humidity: <95% R.H. from 0°C to 40°C

**Power:** 100/120/220/240Vrms, +5%, -10%, 90VA max., 48-400Hz

**Battery back-up** (for non-volatile memory): with instrument switched off all current modes and data will be maintained for at least 10 years after instrument delivery

**Dimensions:** 89mm H, 212.3mm W, 345mm D (3.5"x8.36"x13.6")

**Weight:** net 6.3 kg (13.9 lbs), shipping 10.6 kg (23.4 lbs)

For adapter cables and other accessories see latest Ordering Guide.

Data subject to change.

# SECTION II

## INSTALLATION

### 2.1 INTRODUCTION

This section provides installation instructions for the Model HP8158B and its accessories. It also includes information about initial inspection and damage claims, preparation for use, packaging, storage and shipment.

### 2.2 INITIAL INSPECTION

Inspect the shipping container for damage. If the container or cushioning is damaged, it should be kept until the contents of the shipment have been checked for completeness and the instrument has been verified both mechanically and electrically.

Procedures for checking the optical operation are given in Section 4. If the contents are incomplete, mechanical damage or defect is apparent, or if an instrument does not pass the operator's checks, notify the nearest Hewlett-Packard office. Keep the shipping materials for carrier's inspection. The HP office will arrange for repair or replacement without waiting settlement.

### 2.3 PREPARATION FOR USE

#### **WARNING**

*To avoid hazardous electrical shock, do not perform electrical tests when there are signs of shipping damage to any portion of the outer enclosure (covers, panels, etc.).*

*When operating the HP8158B in the vertical position i.e. standing on the rear panel feet, care should be taken to ensure the instrument does not fall over and cause operator injury.*

### 2.4 POWER REQUIREMENTS

The instrument requires a power source of 100/120/220/240 Vrms (+10%, -5%) at a frequency of 48-400 Hz single phase. The maximum power consumption is 90 VA.

### 2.5 LINE VOLTAGE SELECTION

#### **CAUTION**

*BEFORE SWITCHING ON THE INSTRUMENT, make sure that the instrument is set to the local line voltage.*

**Model HP8158B  
Installation**

The switch is combined with the power line voltage receptacle on the rear panel. If it is necessary to change the setting, **THE POWER CORD MUST FIRST BE DISCONNECTED**. Then insert a screwdriver into the recess at the left-hand side of the assembly and prise open the cover. Figure 2-1 shows the main details of the assembly. To change the voltage setting, the selector must be removed and then replaced with the new setting value displayed. If necessary, change the fuse in accordance with the new voltage setting.

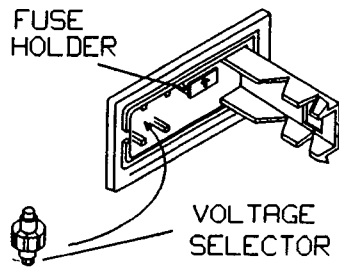

Figure 2-1. Line Voltage Switch Assembly.

VOLTAGE	100/120V	220/240V
FUSE	T 800mA	T 400mA

## 2.6 POWER CABLE

In accordance with international safety standards, this instrument is equipped with a three-wire power cable. When connected to an appropriate ac power receptacle, this cable grounds the instrument cabinet. The type of power cable shipped with each instrument depends on the country of destination. Refer to Figure 2-2 for the part numbers of the power cables available.

### WARNING

*To avoid the possibility of injury or death, the following precautions must be followed before the instrument is switched on.*

- a) *If this instrument is to be energised via an autotransformer for voltage reduction, ensure that the Common terminal is connected to the grounded pole of the power source.*
- b) *The power cable plug shall only be inserted into a socket outlet provided with a protective ground contact. The protective action must not be negated by the use of an extension cord without a protective conductor.*
- c) *Before switching on the instrument, the protective ground terminal of the instrument must be connected to a protective conductor. This is verified by using the power cord which is supplied with the instrument.*

## Model HP8158B Installation

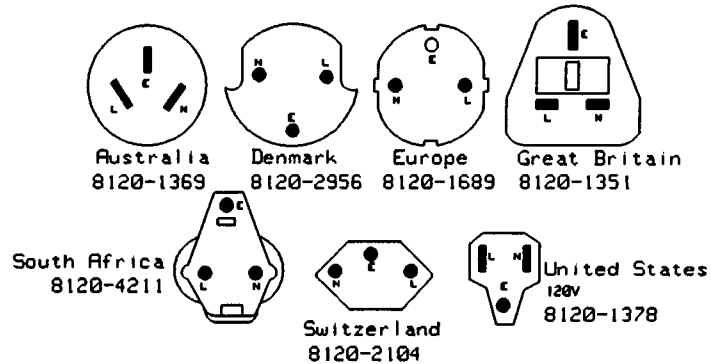

Figure 2-2. Power Cables - Plug Identification

The following work should be carried out by a qualified electrician - all local electrical codes being strictly observed. If the plug on the cable does not fit the power outlet, or the cable is to be attached to a terminal block, cut the cable at the plug end and re-wire it.

The color coding used in the cable will depend on the cable supplied (see Figure 2-2). If a new plug is to be connected, it should meet local safety requirements and include the following features:

- Adequate load-carrying capacity (see table of specifications in Section 1).
- Ground connection.
- Cable clamp.

### 2.7 HP-IB CONNECTOR

The rear panel HP-IB connector (Fig 2-3), is compatible with the connector on Cable Assemblies 10833A, B, C and D. If a cable is to be locally manufactured, use connector male, HP part number 1251-0293.

### 2.8 HP-IB LOGIC LEVELS

The HP8158B HP-IB lines use standard TTL logic, the levels being as follows:

True = Low = digital ground or 0V dc to 0.4V dc,

False = High = open or 2.5V dc to 5V dc.

All HP-IB lines have LOW assertion states. High states are held at 3.0V d.c. by pull-ups within the instrument. When a line functions as an input, approximately 3.2mA of current is required to pull it low through a closure to digital ground. When a line functions as an output, it will sink up to 48mA in the low state and approximately 0.6mA in the high state.

**NOTE:** Isolation, the HP-IB line screens are not isolated from ground.

## Model HP8158B Installation

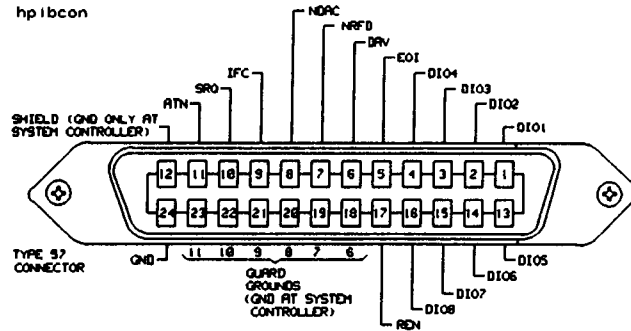

Figure 2-3. HB-IB Connector

### 2.9 OPERATING ENVIRONMENT

The operating temperature limits are 0 deg C to 55 deg C. The specifications also apply over this range.

### 2.10 CLAIMS AND REPACKAGING

If physical damage is evident or if the instrument does not meet specification when received, notify the carrier and the nearest Hewlett-Packard Service Office. The Sales/Service Office will arrange for repair or replacement of the unit without waiting for settlement of the claim against the carrier.

### 2.11 STORAGE AND SHIPMENT

The instrument can be stored or shipped at temperatures between minus 40 deg C and plus 75 deg C. The instrument should be protected from temperature extremes which may cause condensation within it.

If the instrument is to be shipped to a Hewlett-Packard Sales/Service Office, attach a tag showing owner, return address, model number and full serial number and the type of service required.

The original shipping carton and packing material may be reusable, but the Hewlett-Packard Sales/Service Office will also provide information and recommendations on materials to be used if the original packing is no longer available or reusable. General instructions for repacking are as follows:

1. Wrap instrument in heavy paper or plastic.
2. Use strong shipping container. A double wall carton made of 350-pound test material is adequate.
3. Use enough shock-absorbing material (3 to 4 inch layer) around all sides of the instrument to provide a firm cushion and prevent movement inside container. Protect control panel with cardboard.
4. Seal shipping container securely.
5. Mark shipping container FRAGILE to encourage careful handling.
6. In any correspondence, refer to instrument by model number and serial number.

Figure 3-1. Front and Rear Panel Controls, Indicators and Connectors

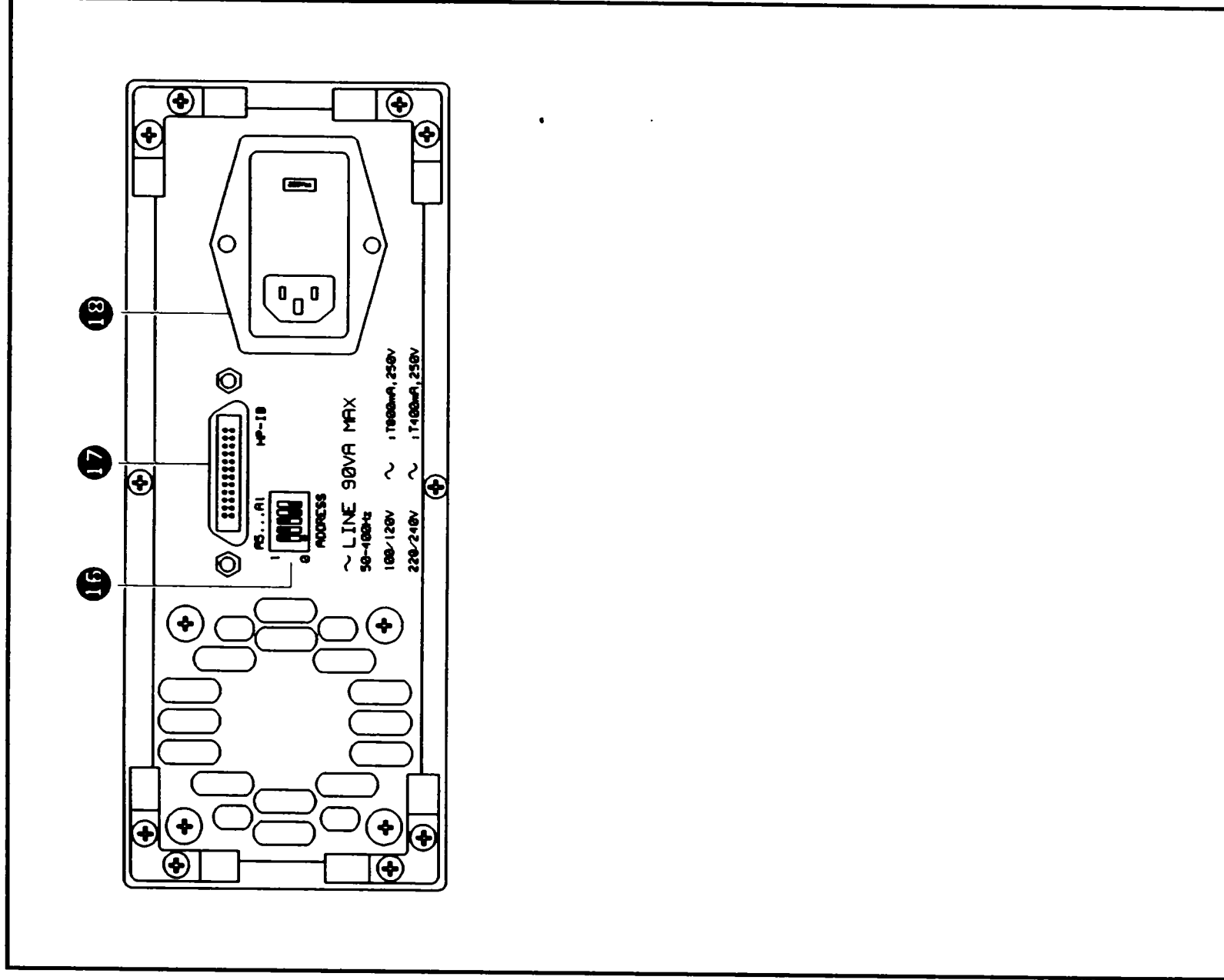
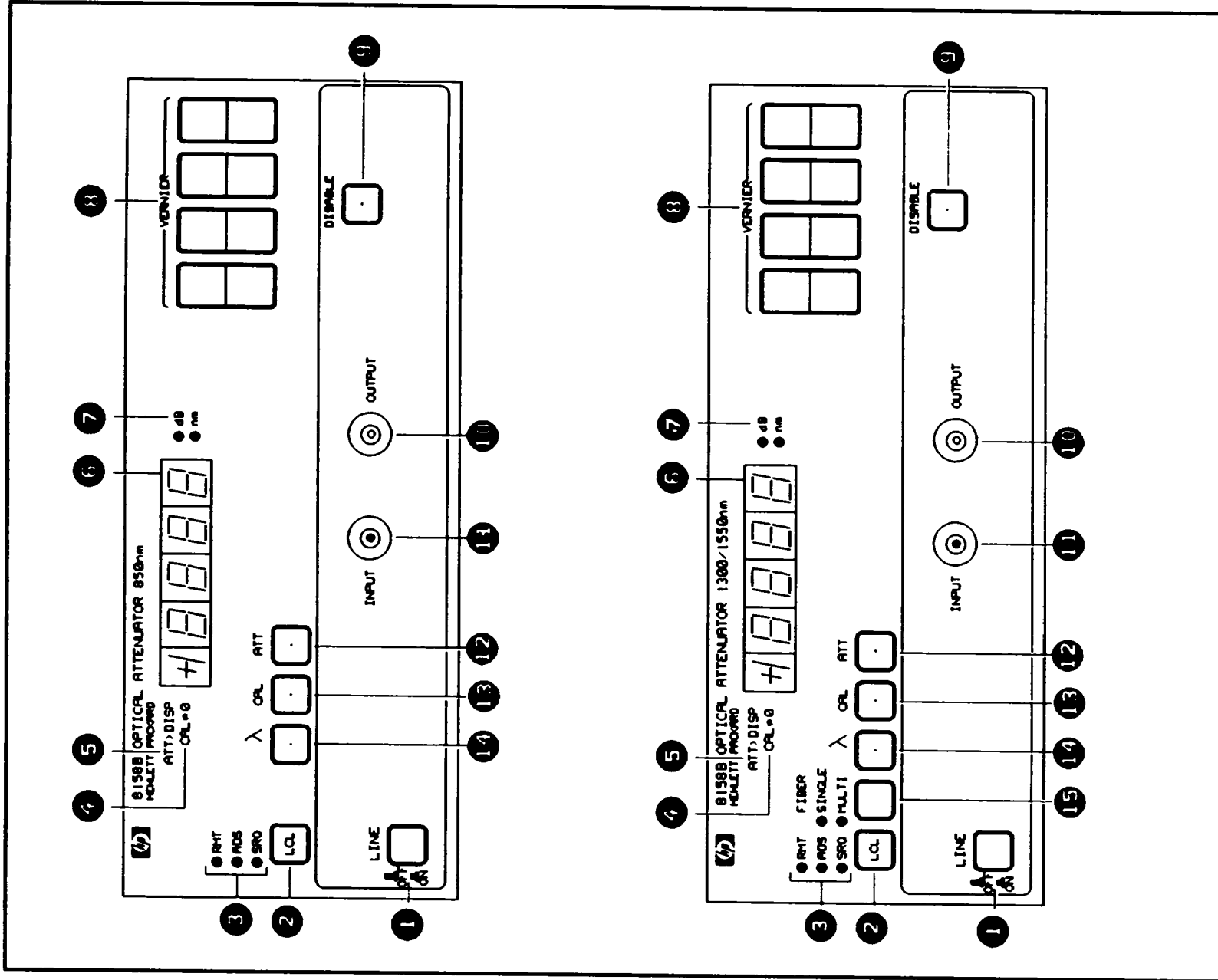

## SECTION III

# OPERATING AND PROGRAMMING

### 3.1 INTRODUCTION

This section explains the functions of controls, indicators and connectors, as well as providing operating and programming information. Figure 3-1 provides a numbered illustration of the front and rear panel controls, and should be folded out when reading the description "Getting to Know Your Instrument " on the following pages. This description should be read before continuing with the more detailed operating information. Programming information is located at the end of this section.

### 3.2 SPECIAL OPERATING CONSIDERATIONS

The following points should be noted before applying power to the instrument:

- ☞ Read the safety summary at the beginning of this manual.
- ☞ Ensure that the VOLTAGE SELECTOR switch on the rear panel is set for operation at the local line voltage.

If any change is made to the setting of the VOLTAGE SELECTOR switch, the fuse must also be changed. Before making either of these changes, switch the instrument off and disconnect the power cord.

#### **WARNING**

##### How to Avoid Potential Exposure to Radiation

*When connecting the Model HP8158B into the optical path between an optical source and optical receiver, complete the connection between the Model HP8158B and receiver first. Then regarding the connection between Model HP8158B and source, make the Model HP8158B connection before the source connection. This avoids any potential exposure to radiation.*

### 3.3 OPERATORS CHECKS

The HP8158B performs a self-test routine at power switch-on. At the start of this routine, all front panel LEDs should be momentarily lit. In the event of a fault being detected, an error code will be presented in the digital display. The error codes and required action are listed as follows:

- ☐ Keyboard test failed. Check that no key is stuck in pressed position.
- Exxx where xxx is a 3-digit number. Indicates a serious fault and instrument should be returned to the nearest Hewlett-Packard Service Office.



### 3.4 GETTING TO KNOW YOUR INSTRUMENT

The following should be read in conjunction with Figure 3-1 which can be folded out to aid understanding.

1. LINE switch. Power on/off switch.
2. LCL key. This key returns the HP8158B to local manual operation when the instrument is under program control. Note that this key is disabled when the LOCAL LOCKOUT command has been sent by the system controller to the instrument.
3. Program status LEDs. When illuminated, the following is indicated.
  - RMT: Indicates remote control. All front panel pushbuttons (except the LCL pushbutton) are disabled.
  - ADS: Indicates that the instrument is being addressed under program control, although the front panel pushbuttons may still be enabled depending on the status of the RMT LED.
  - SRQ: Indicates that a Service Request has been sent by the instrument to the controller.
4. CAL  $\neq$  0 LED. Indicates that a non-zero value is currently selected for the CAL factor (see description for CAL key 13). The difference between the **displayed** attenuation and **actual** attenuation = the CAL factor.
5. ATT > DISP LED. Indicates that the selected attenuation is less than the instrument's insertion loss. The displayed attenuation at (6) automatically includes instrument insertion loss (single mode = 3 dB (only opt. 002), multimode = 1.0 dB). For accurate measurements, therefore, the attenuation should be set  $\geq$  insertion loss.
6. Digital display. Displays numerical value of currently selected parameter (wavelength, CAL-factor or attenuation).
7. Unit LEDs. Operate in conjunction with the digital display (6) to indicate the base units of the currently selected parameter.
8. VERNIER rocker keys. Used to vary parameter values.
9. DISABLE key. Used to enable/disable the optical output (10). When the key LED is illuminated, the optical output is disabled.
10. Connector for optical output.
11. Connector for optical input.
12. ATT key. Used to set the attenuation. When pressed, current attenuation is displayed and can be changed via VERNIER keys (8).
13. CAL key. Used to offset the **displayed** attenuation value (as set via key (12)). When pressed, current offset (CAL factor) is displayed and can be changed via VERNIER keys (8). NOTE: When

**Model HP8158B  
Operating and Programming**

CAL key is already active, i.e. key LED illuminated, holding the key down will display the insertion loss for the selected fiber mode.

14.  $\lambda$  key. Used for setting the wavelength. When pressed, the current wavelength is displayed and can be changed via VERNIER keys (8).
15. FIBER key. Used to adapt instrument operation for single or multimode fibers. The current selection is indicated by an illuminated LED. This key only exists in option 002.

#### **Rearpanel Connectors**

16. HP-IB address switch.
17. HP-IB connector.
18. LINE connector assembly (including VOLTAGE SELECTOR switch). A three-pronged receptacle to provide chassis ground through the power cable for operator protection.

## **3.5 SETTING THE ATTENUATION**

### **3.6 Basic Considerations**

When you press the ATTenuation key on the HP8158B front panel, the displayed setting automatically takes 2 factors into consideration:

1. The operating **wavelength** of the optical input. (Selected by  $\lambda$  key 14).
2. The HP8158B's **insertion loss**. (Selected by FIBER key 15). Insertion loss is only considered for opt. 002, as opt. 001 has no single-mode option.

Because attenuation is dependent on **wavelength**, you must first set the HP8158B to the operating wavelength of the optical input to ensure attenuation accuracy. To set the wavelength, press  $\lambda$  key (14) and the current setting will be displayed. You can then change this setting via VERNIER keys (8), and the HP8158B adjusts the attenuating filters automatically.

#### **NOTE**

Although instrument operation for opt 002 is specified for wavelengths 1300nm and 1550nm in single-mode and 1300nm in multimode, the setting range is 1200nm to 1650nm. Similarly, for opt 001 the setting range is 600nm to 1200nm, though specified for 850nm. For any setting other than that specified, the attenuation is based on a wavelength correction factor which is typically interpolated from the specified values.

Regarding **insertion loss**, for option 002 only, 2 values (one each for single-mode and multimode) are stored in the HP8158B memory. When you select single- or multimode via the FIBER key, the corresponding value is automatically recalled for taking into account on the attenuation setting. The 2 values are as follows:

- 3 dB for single-mode
- 1 dB for multimode

**Model HP8158B  
Operating and Programming**

**NOTE**

If your attenuation setting is lower than the currently recalled insertion loss, ATT > DISP LED (5) will illuminate. This informs you that the actual attenuation is greater than your setting. The currently recalled insertion loss can be displayed by holding down the activated (key LED on) CAL key.

With wavelength and fiber type selected, the HP8158B now performs automatic correction for any attenuation settings you make via ATT key (12).

### 3.7 Optimize The Display With The CAL Key

The CAL key can be used to change the displayed attenuation setting without a corresponding change in actual attenuation at the output. Two examples of how this would be useful are as follows:

1. Making relative settings. If you want the displayed attenuation to be referenced to 20 dB, then entering -20 dB via the CAL key will set 20 dB **actual** attenuation to be the 0 dB **displayed** setting.
2. Adjusting the displayed attenuation to take known external losses into account. Consider the typical setup shown in the following figure 3-2.

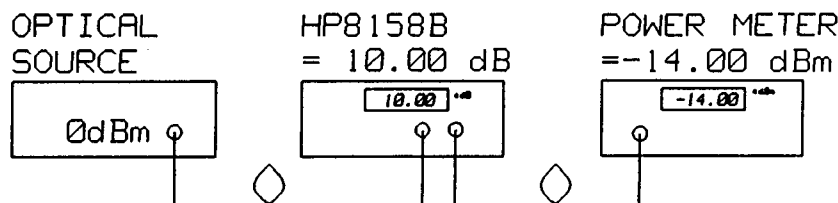

Figure 3-2.

Total attenuation from source to power meter is 14 dB, although the HP8158B's displayed attenuation setting is 10 dB. There are therefore 4 dB external losses. By entering 4 dB via the CAL key, the displayed attenuation setting will change to 14 dB to include the 4 dB external losses, thus corresponding to power meter reading. Note that the CAL ≠ 0 LED is now illuminated. This informs you that the displayed attenuation has been corrected via the following formula to include the CAL factor:

$$\text{Actual attenuation} + \text{CAL factor} = \text{Displayed attenuation}$$

Substituting the values in the example gives the following:

$$10\text{dB} + 4\text{dB} = 14\text{dB}$$

**NOTE**

When determining the external losses, make sure the HP8158B attenuation setting is  $\geq$  the currently stored insertion loss. At a lower setting, the ATT > DISP LED illuminates to indicate an invalid setting, i.e. the attenuation is greater than the displayed setting.

## 3.8 PROGRAMMING

### 3.9 WHAT YOU NEED TO KNOW . . . .

Programming information in this section is restricted to HP8158B specifics, and assumes that you have a working knowledge of HP-IB intrinsics. If you are not familiar with HP-IB, then refer to the following publications:

- HP Publication 5952-0156, "Tutorial Description of HP-IB"
- ANSI/IEEE-488-1978, "Digital Interface for Programmable Instrumentation" published by the Institute of Electrical and Electronic Engineers

For a complete list of the HP8158B programming commands, refer to the blue pages at the end of this section.

### 3.10 . . . About The HP8158B's HP-IB Capabilities

The HP8158B interfaces to the HP-IB as defined by the IEEE Standard 488-1978. The interface functional subset which the HP8158B implements is specified in Table 3-1.

Table 3-1. HP-IB Capabilities

MNEMONIC	INTERFACE FUNCTION NAME
SH1	SOURCE HANDSHAKE CAPABILITY
AH1	ACCEPTOR HANDSHAKE CAPABILITY
T6	BASIC TALKER, SERIAL POLL, UNADDRESSED IF MY LISTEN ADDRESS
L4	BASIC LISTENER, UNADDRESSED IF MY TALK ADDRESS
SR1	SERVICE REQUEST CAPABILITY
RL1	REMOTE/LOCAL CAPABILITY
PP0	NO PARALLEL POLL CAPABILITY
DC1	DEVICE CLEAR CAPABILITY
DT0	NO DEVICE TRIGGER CAPABILITY
CO	NO CONTROLLER CAPABILITY

### 3.11 . . . About Programming Examples in This Section

Programming examples are given in this section to aid explanation. These examples assume the following:

- an HP9000, Series 200 or 300 Computer is controller
- that BASIC is the programming language
- the HP8158B is set to HP-IB address 28 (factory setting)

**Model HP8158B**  
**Operating and Programming**

### 3.12 GETTING STARTED

If this is the first time you are programming the HP8158B, the following gives you a few simple tasks to carry out prior to detailed program development. The benefits are twofold in that it gets you started on programming the HP8158B, at the same time checking remote operation of your instrument.

### 3.13 Setting the Address

Each instrument that you connect to the interface bus has a unique "address", and the HP8158B is no different. The address used in a typical BASIC statement takes the form "7xx" where:

- 7 = the interface select code
- xx = the instrument address, which can be any integer from 00 to 30 (21 is usually reserved for the controller)

The HP8158B is preset at the factory to address 28 as shown in the following illustration of the address switch (you can check this by pressing the front panel LCL key to display the address).

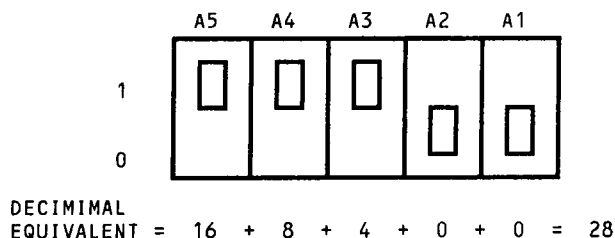

If you are satisfied with this address, then continue with the next task "Checking Remote Operation" (Note that all examples in this section assume the address is set to 28).

If you want to change the address, first ensure that the HP8158B is in **local mode** and **not addressed** (i.e. the ADS and RMT LEDs (3) are not illuminated), then change the bit settings on rear panel address switch (16). Now press the front panel LCL key, and the new address will be activated and displayed.

### 3.14 Checking Remote Operation

You can now check remote operation using a few simple commands as follows:

10 DIM A\$(7)	
20 CLEAR 728	-clears HP8158B's input/output buffers
30 OUTPUT 728; "ATT 5.00 dB"	-sets attenuation to 5.00 dB
40 OUTPUT 728; "ATT?"	-interrogates attenuation setting
50 ENTER 728;A\$	-transfers setting data to controller
60 PRINT A\$	
70 END	

The controller output should read " 5.00" which indicates that both the Listener and Talker functions of the HP8158B are operating correctly.

### 3.15 SENDING DATA TO THE HP8158B (LISTENER FUNCTION)

All the settings you can make via front panel switches can also be programmed via HP-IB. To aid explanation, consider the following programming example:



**Model HP8158B  
Operating and Programming**

SRQ mask	8 characters
CAL factor	12 characters
Attenuation	12 characters
Wavelength	16 characters

### 3.17 STATUS/ERROR REPORTING (TALKER FUNCTION)

Another important feature of the HP8158B is that you can program it to interrupt the controller when certain status/error conditions are met. The Require Service (SRQ) message is used to implement this feature and is independent of all other HP-IB activity. However, the HP8158B **must be programmed** for the interrupt, via the SRQ mask, before the interrupt will take place. The possible interrupt conditions that can be programmed via the SRQ mask are listed as follows:

- Self-Test Error            If an error is detected by the self-test at power-on, or via the "TST?" command (e.g.OUTPUT 728;"TST?").
  
- ATT > DISP                If the attenuation is set to a value lower than the current insertion loss.
  
- Settled                     When the HP8158B's hardware has settled to the new setting values. (Hardware Ready).
  
- Parameter Error            A wrong value has been set for a parameter.
  
- Message Available         When the HP8158B is ready to respond to an interrogation command.
  
- Syntax Error                An invalid instruction has been sent.

These 6 interrupt conditions are monitored by an 8-bit Status Register, the content of this register being referred to as the Status Byte.

### 3.18 Status Register and Status Byte

The following shows which bit in the Status Register is allocated to which interrupt condition:

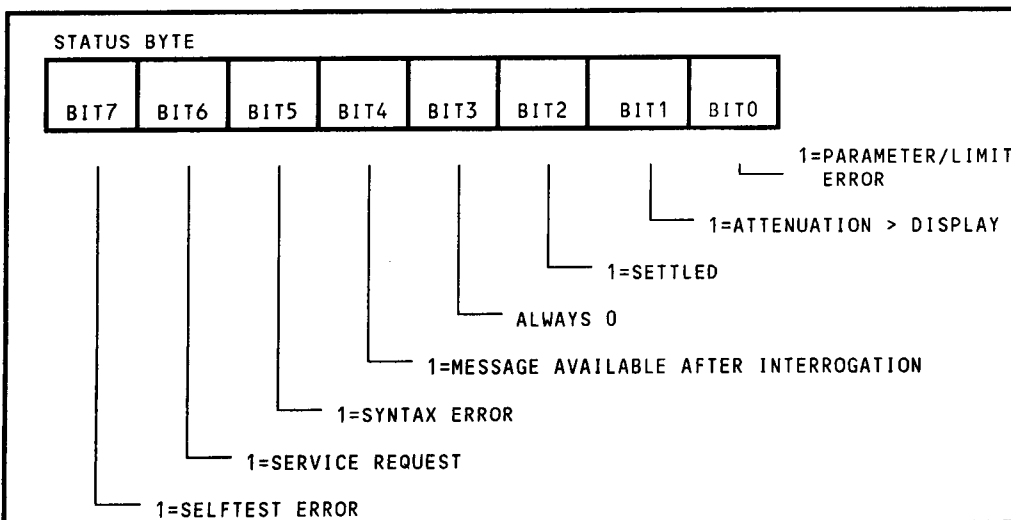

**Model HP8158B**  
**Operating and Programming**

When an interrupt condition is true, the corresponding bit in the status Register is set to 1 - **independent of the SRQ mask setting**. However, an interrupt (SRQ) will only occur when the SRQ mask has been set for that condition. It is therefore possible for one or more bits of the Status Register to be true without the HP8158B causing an interrupt - **because the SRQ mask has not been set for these bits**.

This is typically the case at power-on or after "Device Clear" - **as the SRQ mask is then set to decimal 000 and all interrupts are disabled**. If the HP8158B is now serial polled or receives the "STB?" command, the decimal equivalent of the Status Byte is returned to the controller - **but the Status Byte remains unchanged**. To clear the Status Byte, the "CSB" (Clear Status Byte) command must be used. For example:

10	DIM A\$[7]	- Dimension of A-string
20	CLEAR 728	- Clears HP8158B's I/O buffers; SRQ mask = 000
30	OUTPUT 728;"CSB"	- Clear Status Byte
40	OUTPUT 728;"wvl?"	- Interrogate wavelength setting.
50	S=SPOLL(728)	- Serial poll of HP8158B
60	IF BIT(S,4) = 0 THEN GOTO 50	- Check Status Byte; if Bit 4=0,repeat Serial poll; if Bit 4=1, message available
70	ENTER 728;A\$	- Transfer wavelength setting to controller
80	PRINT A\$	- Print result
90	OUTPUT 728;"CSB"	- Clear Status Byte
100	END	

If the SRQ mask is set for certain conditions, and one of these conditions occur, bit 6 of the Status Register will go true ("1" state), the SRQ LED on the front panel will illuminate, and the HP-IB SRQ message will be sent. At this point, it will be necessary to address the HP8158B as talker by using the Serial Poll command or "STB?" command:

10	A=SPOLL(728)	- Transfers Status Byte to variable "A"
20	PRINT A	
30	END	
	or	
10	OUTPUT 728;"STB?"	- Interrogates the Status Byte
20	ENTER 728;A	- Transfers the Status Byte to variable "A"
30	PRINT A	
40	END	

The Status Byte is returned to the controller as a decimal number which can be broken down into its 8 binary components to determine which bit has gone true. At the same time, the Status Register is cleared and SRQ set false.

**NOTES**

- Once SRQ is set true, the Status Byte remains unchanged until serial polled or interrogated via the "STB?" command. For any interrupt condition going true during this period, the corresponding bit in the Status Register **will not be set**. Instead, the "1" state will be held in HP8158B memory and loaded into the Status Register after it is cleared e.g. by serial poll.
- For this reason, if several conditions are enabled by the SRQ mask and they all go true, only the condition that occurred first will have its bit set in the Status Register. The bit settings for the other conditions will be held in HP8158B memory, and loaded simultaneously into the Status Register after it is cleared. If you have set more than one condition by the SRQ mask, therefore, your program should serial poll the HP8158B twice to ensure that the Status Register is cleared and SRQ set false.



### 3.19 SETTING THE SRQ MASK

The SRQ mask can be set to mask bits 0-5 and bit 7 on the Status Register. Default mask value is 0 i.e. all interrupt conditions are disabled and no SRQ can be generated. To set the mask first determine which conditions you want to interrupt the controller, e.g., parameter error, syntax error, etc. Determine the decimal number (1-191) corresponding to those conditions. A "1" in the mask byte enables the corresponding interrupt condition. Then output the "SRE" instruction mnemonic followed by the decimal number. The following shows the Status Register and the SRQ mask set for bit 1 and bit 5, syntax error and parameter error. (OUTPUT 728;"SRE33").

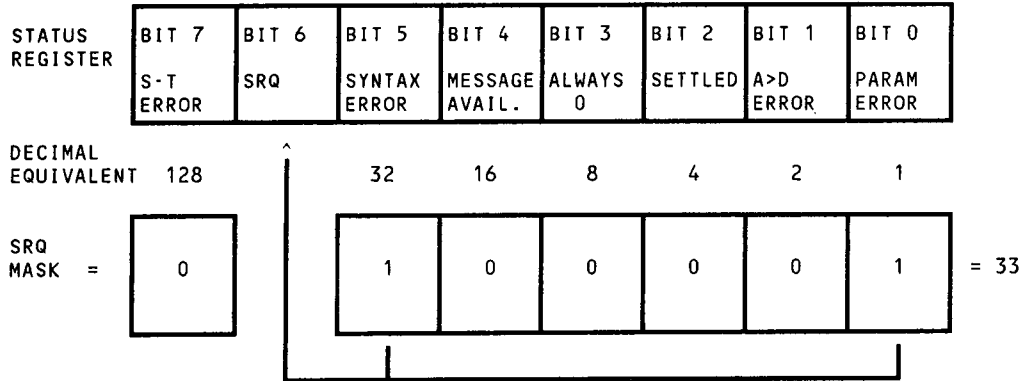

### 3.20 Condition Register

Whereas the Status Register monitors events, i.e. when an interrupt condition occurs, a bit is set and remains set until the register is cleared, the condition register monitors the current status regarding "settled" and "attenuation > display".

The bit allocation in the condition register is as follows:

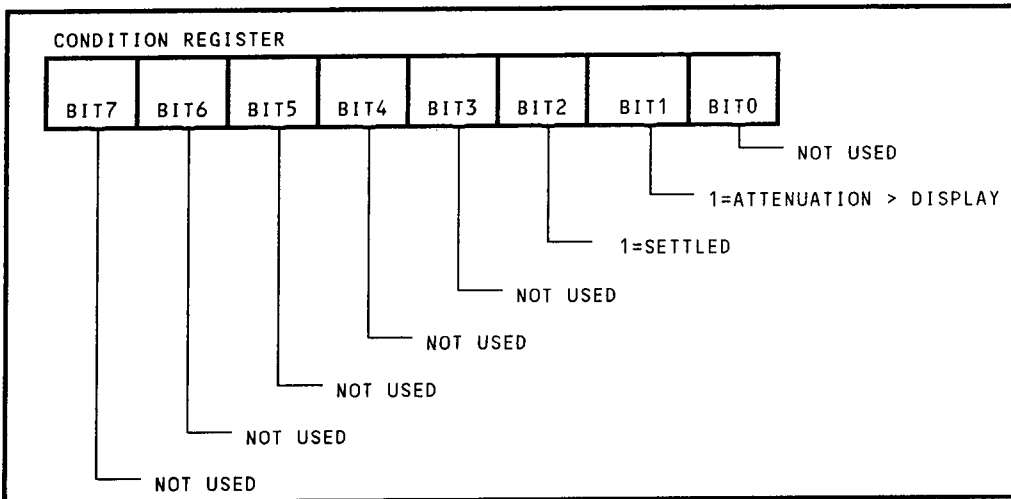

When the condition register is interrogated via the "CNB?" command, the contents are returned to the controller as a decimal number. This number can then be broken down into its binary components to determine which bit has been set to "1".

## HP8158B COMMAND SUMMARY

### SETTINGS (LISTENER FUNCTION)

Parameter/Operation	Mnemonics	Data	Unit	Comment
Select Single-Mode	F	1		This only applies to opt. 002, a Parameter/Limit Error will be given if used for opt. 001.
Select Multimode	F	2		
Enable Output	D	0		
Disable Output	D	1		
Set Wavelength	WVL	value	M MM UM NM PM	meter. Default if no unit defined millimeter micrometer nanometer picometer
Set Attenuation	ATT	value	DB	Default is dB if no unit defined
Set CAL Factor	CAL	value	DB	Default is DB if no unit defined
Set SRQ Mask	SRE	value		value = decimal number (0-191). A "1" in the binary equivalent sets SRQ on this condition.
Clear Status Byte	CSB			Always clears Status Byte independent of SRQ state.
Clear Device	CLR			Clears all I/O buffers. Same as Universal Device Clear Command.

### INTERROGATING SETTINGS (TALKER FUNCTION)

Parameter/Operation	Mnemonics	Comment
Learn Mode	LRN?	Returns 56-character string detailing all settings.
Interrogate setting	F? WVL? CAL? ATT?	Returns integer (1 or 2) for fiber setting. Returns 11-character string for $\lambda$ setting. Always in meters. Returns 7-character string for CAL factor. Always in dB. Returns 7-character string for attenuation setting. Always in dB.
	D?	Returns integer (0 or 1) for output off/on.
Interrogate insertion loss	LOSS?	Returns 7-character string for insertion loss. Always in dB.

**Model HP8158B  
Operating and Programming**

**STATUS/ERROR REPORTING (TALKER FUNCTION)**

Interrogation	Mnemonics	Comment
Status Byte	STB?	Returns 3-digit integer (000-191). With SRQ false, does not clear Status Byte.
Status Byte Mask	SRE?	Returns 3-digit integer (000-191)
Condition Byte	CNB?	Returns 2-digit integer (00-06)
Self-test	TST?	Executes self-test and returns 0 or 1 to indicate passed or failed
Error Number	ERR?	Returns 3-digit integer representing HP8158B error code (details given in Service info). 000 means no error. An error code is only available if bit 7 (self-test) in the Status Byte has been set. Other error conditions in the Status Byte will not cause an error code. On readout, the error code is transferred to the 'Last Error Number' register.
Last Error Number	LERR?	Returns 3-digit integer for last active error. This is a destructive readout.
Operation Complete	OPC?	1 if no further command to interpret and execute in the input buffer. 0 if further commands in the input buffer.
Identifier	IDN?	Returns 40-character string identifying currently installed firmware and manufacturer model no.

**UNIVERSAL COMMANDS**

Command	ASCII Character	Equivalent Forms		
		Binary	Octal	Decimal
Device Clear	DC <sub>4</sub>	00010100	024	20
Selected Device Clear	EOT	00000100	004	4

Both "CLEAR" commands clear all input/output buffers, reset SRQ mask to all disabled and SRQ to false, but have no effect on HP8158B mode/parameter settings.

# SECTION IV

## PERFORMANCE TESTS

### 4.1 INTRODUCTION

The procedures in this section test the optical performance of the instrument. The complete specifications to which the HP8158B is tested are given in Table I-1. All tests can be performed without access to the interior of the instrument.

### 4.2 EQUIPMENT REQUIRED

Equipment required for the performance test is listed in Table 4-1. Recommended Test Equipment. Any equipment which satisfies the critical specifications given in the table may be substituted for recommended models.

Table 4-1. Recommended Test Equipment

Instrument/Accessory	Rec. Model	Critical Specification	Req. for Option
<b>Power Meter Standard</b>	<b>HP8152A</b>	Accuracy: < 2%, Dynamic Range > 60dB. Accuracy (rel.) <0.15dB	001 002
	<b>HP81521B</b>		002
	<b>HP81520A</b>		001
Lens Adapter for multimode fiber	HP81050BL		002
	HP81050AL		001
Lens Adapter for single-mode fiber	HP81010BL		002
Connector Adapter	HP81000AA		001 002
Multimode Fiber	HP81501AC	Opt.011	001 002
	HP81501SC	Opt.013	
Single-Mode Fiber	HP81101AC	Opt.011	002
	HP81101SC	Opt.013	
CW Laser Source		1300 nm 0dBm into single-mode fiber	002
Single-Mode Fiber	HP81101xx	Source dependent	002
CW Laser Source		1550 nm 0dBm into single-mode fiber	002
Multimode Fiber	HP81501xx	Source dependent	001 002
Cleaning Kit	HP15475A		001 002
CW Laser Source	<b>HP8150A</b>	850nm 0dBm into multimode fiber	001

**Model HP8158B  
Performance Tests**

**4.3 TEST RECORD**

Results of the performance test may be tabulated on the Test Record provided at the end of the test procedures. It is recommended that you fill out the Test Record and refer to it while doing the test. Since the test limits and setup information are printed on the Test Record for easy reference, the record can be also be used as an abbreviated test procedure (if you are familiar with test procedures). The Test Record can also be used as a permanent record and may be reproduced without written permission from Hewlett-Packard.

**4.4 TEST FAILURE**

If the HP8158B fails any performance test, return the instrument to the nearest Hewlett-Packard Sales/Service Office for repair.

**4.5 INSTRUMENTS SPECIFICATION**

Specifications are the performance characteristics of the instrument which are certified. These specifications, listed in Table 1-1 are the performance standards or limits against which the HP8158B can be tested. Table 1-1 also lists some supplemental characteristics of the HP8158B and should be considered as additional information.

Any changes in the specifications due to manufacturing changes, design, or traceability to the National Bureau of Standards will be covered in a manual change supplement or revised manual. The specifications listed here supercede any previously published.

**4.6 PERFORMANCE TEST**

The performance tests given in this section are separated into Total Insertion Loss Test, Attenuation Accuracy Test and Attenuation Repeatability Test. Perform each step in the tests in the order they are given using the corresponding test equipment.

**NOTE**

Make sure that all optical connections of the test setups given in the procedure are dry and clean. For cleaning use accessory kit Model HP15475A. **DO NOT USE IMMERSION OIL** (see cleaning procedure).

The Optical Cables from the Laser Source to the 8158B and from the Attenuator to the Power Meter must be fixed on the table to ensure minimum cable movement during the tests.

*All tests and equipment mentioned in the Performance Test section refer to tests carried out with the Diamond® HMS-10/HP connectors.*

**4.7 TOTAL INSERTION LOSS, ATTENUATION ACCURACY AND ATTENUATION REPEATABILITY**

Equipment required for: 8158B Opt.001

**850nm multimode tests**

CW Laser Diode Source with constant output power 850nm wavelength.  
Power Meter Standard with Optical Head, connector adaptor and lens adapter for multimode fiber. (8152A; 81520A; 81050AL; 81000AA)  
Optical Cable (50 um) HP81501AC  
Optical Cable (50 um) HP81501xx (Source dependent)

Equipment required for: 8158B Opt.002

**1300nm multimode tests**

CW Laser Diode Source with constant output power 1300nm wavelength.  
Power Meter Standard with Optical Head, connector adaptor and lens adapter for multimode fiber. (8152A; 81521B; 81050BL; 81000AA)  
Optical Cable (50 um) HP81501AC  
Optical Cable (50 um) HP81501xx (Source dependent)

**1300nm single-mode tests**

CW Laser Diode Source with constant output power 1300nm wavelength.  
Power Meter Standard with Optical Head, connector adaptor and lens adapter for single-mode fiber. (8152A; 81521B; 81010BL; 81000AA)  
Optical Cable (9 um) HP81101AC  
Optical Cable (9 um) HP81101xx (Source dependent)

**1550nm single-mode tests**

CW Laser Diode Source with constant output power 1550nm wavelength.  
Power Meter Standard with Optical Head, connector adaptor and lens adapter for single-mode fiber. (8152A; 81521B; 81010BL; 81000AA)  
Optical Cable (9 um) HP81101AC  
Optical Cable (9 um) HP81101xx (Source dependent)

Model HP8158B  
Performance Tests

4.8 TOTAL INSERTION LOSS TEST

Specification:

Insertion loss (including both connectors) < 4.0 dB with single-mode fiber 9  $\mu$ m.  
Insertion loss (including both connectors) < 2.0 dB with multimode fiber 50  $\mu$ m.

Carry out the following TOTAL INSERTION LOSS tests for 850nm multimode for Opt.001, or 1300nm multimode, 1300nm single-mode and 1550nm single-mode for Opt.002, using the equipment listed previously.

1. Using the VERNIER rocker keys set the 8158B attenuation to minimum. (No further display change and ATT > DISP is lit).
2. Connect the equipment as shown in Figure 4-1

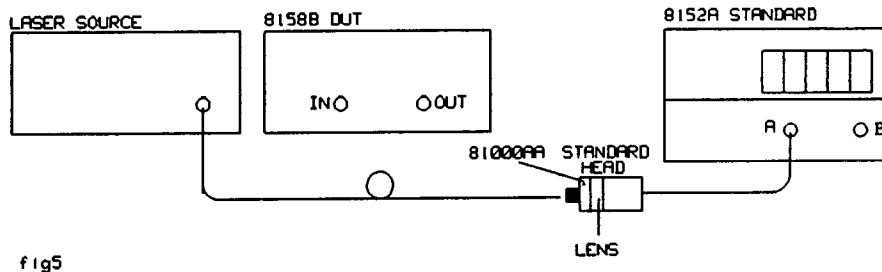

fig5

Figure 4-1. Test Setup for Reference Measurement

3. Set the Average Power Meter to Autorange. Display [dB].
4. Set DISPlay to REference on the power meter 8152A.
5. Connect the equipment as shown in Figure 4-2.

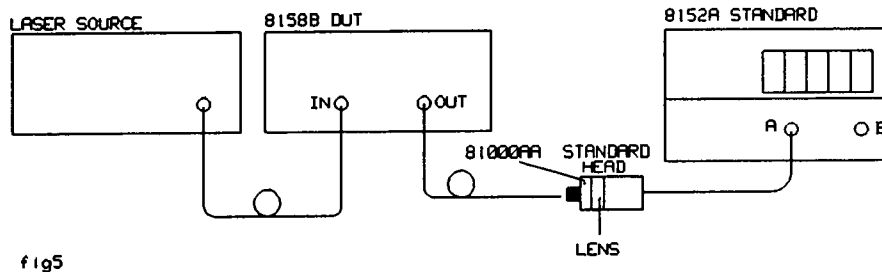

fig5

Figure 4-2. Test Setup for Total Insertion Loss

6. Enable the attenuator 8158B output and record the power meter 8152A reading (in dB) on the Test Record and check that it is within specifications.

Model HP8158B  
Performance Tests

4.9 ATTENUATION ACCURACY

Specifications:

Linearity (connector uncertainty not included)  $\pm 0.4$  dB for single-mode,  $\pm 0.2$  dB for multimode.

Carry out the following ATTENUATION ACCURACY tests for 850nm multimode or 1300nm single-mode and 1550nm single-mode using the equipment listed previously.

1. Set 8158B as follows:

FIBER to SINGLE (Required only for Opt.002)

$\lambda$  as required

CAL to the factory determined insertion loss with negative sign for the selected wavelength (see Note).

ATT to 0.00 dB

2. Connect equipment as shown in Figure 4-3.

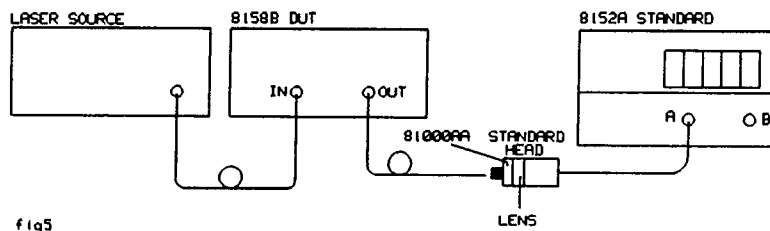

Figure 4-3.

3. Set 8158B output power level as 0.00 dB reference level on the Average Power Meter and check following attenuation settings for  $\pm 0.2$  dB accuracy for Opt.001 or  $\pm 0.40$  dB accuracy for Opt.002 and note the results in the Test Records.

0.00 dB = Reference

1 dB	11 dB
2 dB	12 dB
3 dB	13 dB
4 dB	14 dB
5 dB	24 dB
6 dB	34 dB
7 dB	44 dB
8 dB	54 dB
9 dB	
10 dB	

Note:

To recall the factory determined insertion loss for the specific wavelength, press the CAL pushbutton two times and note the displayed value. Set the CAL factor to the same value but with negative sign. Example: Factory determined insertion loss is 3.00 dB. Set CAL factor to -3.00. This ensures that all attenuators within the 8158B are set to minimum attenuation when the attenuation is set to 0.00 dB.



Model HP8158B  
Performance Tests

4.10 ATTENUATOR REPEATABILITY

Specifications:

Repeatability after any parameter has been changed and reset  $< \pm 0.04$  dB.

Equipment required:

Use the same equipment, test setup and 8158B settings as has been used for the ATTENUATION ACCURACY test. ( either for 850nm, 1300nm or 1550nm wavelength )

1. Set the 8158B attenuation to the values shown in step 3 and note the AVG Power Meter reading in the Test Record.
2. Set the 8158B attenuation to any other value ( e.g.0.00dB ) and then back to the previous value. Note the AVG Power Meter reading in the Test Record and check that the second reading is within  $\pm 0.04$ dB of the first reading.
3. Repeat steps 1 and 2 for following attenuation settings:

5dB  
12dB  
24dB  
36dB  
48dB  
50dB  
53dB