

# BitAlyzer<sup>®</sup>1500 Bit Error Rate Analyzer



Bit Error Rate Testing products from SyntheSys Research, Inc., have always provided more than simple error counts by including patented, BitAlyzer<sup>®</sup> Error Analysis<sup>™</sup> tools that help users identify the source of bit errors. Now, with the introduction of the BA1500 Bit Error Analysis System, SyntheSys Research BERT capabilities have been further extended to include a comprehensive set of physical layer test tools including Eye Pattern Display, Eye Mask Testing, Jitter Measurement, BER Bathtub, and Q-Factor measurements. It's like getting five test instruments in one box, and is ideal for design debug, device characterization, manufacturing test, and monitoring of digital signals.

The BA1500 supports wide adjustment ranges for amplitude, offset, and logic threshold for both differential and single-ended I/O, with built-in settings for common logic families. Moreover, the pattern generator output provides very high signal quality with fast rise times and low jitter. This combination

of features makes the BA1500 ideal for device characterization and margin testing.

With a single input, the BA1500 has the capability to measure BER, perform Error Analysis<sup>™</sup>, measure random, deterministic, and total jitter, display and characterize actual eye patterns, perform lightning-fast mask tests, display BER contour, and measure Q-factor. This unique combination of capabilities allows designers and test engineers to replace several instruments with a single, cost-effective BA1500 that provides faster and more accurate results. The BA1500 is part of a new era in BERT capability, performance and efficiency, further establishing SyntheSys Research as a leader in data communications test technology.

*For white papers, tutorials, and real-time video demonstrations, visit:*

[www.synthesysresearch.com](http://www.synthesysresearch.com)

## FEATURES

- Up to 1.5 Gbit/sec Pattern Generator/Error Detector
- PRBS or 8-Mbit User-Defined Patterns
- Built-In Clock Source
- Adjustable Amplitude, Offset, Logic Threshold and Termination
- Differential and Single-Ended I/O
- BitAlyzer<sup>®</sup> Error Analysis<sup>™</sup>
- Eye Diagram Display with Automatic Measurements
- ANSI Jitter Measurements (RJ, DJ and TJ)
- Fast Eye Mask Testing
- Q-Factor Measurement
- BER Contour with Automatic Mask Creation
- Forward Error Correction Emulation
- Error Mapping

## APPLICATIONS

- Semiconductor Characterization
- Production Eye Mask, BER, and Jitter Testing
- Satellite Communications
- Wireless Communications
- Fiber Optic System and Component Testing
- Forward Error Correction Evaluation

**SYNTHE SYS**  
RESEARCH, INC.

[www.synthesysresearch.com](http://www.synthesysresearch.com)  
(650) 364-1853

BitAlyzer<sup>®</sup>1500

PATENTS GRANTED AND PENDING

# Standard Features

## GETTING STARTED

The BA1500 has the most advanced user interface found on any bit error rate tester. The display offers easy-to-press control buttons and generous status readouts. From our Home page view, users can learn how to get started with the instrument. Convenient links to the internet, technical support e-mail, and network and printer setup can be accessed as well.

Users also receive a "Getting Started" guide with simple step-by-step tutorials that introduce the analyzer and some of the new analysis features. Within an hour, users are performing instrument setup, making error measurements, and studying bit error statistics.



The Home view is the starting point for the BA1500. The touchscreen buttons on the right-hand side are used to select the view, operating mode, and configuration of the analyzer.

## PATTERN GENERATOR

The BA1500 includes an internal data generator capable of generating any one of five pseudo-random data streams, or a user-defined sequence up to 8 Mbits long. Data generation is controlled by either the standard internal clock source or an externally supplied clock input. Variable delay is supported with 0.1% resolution within a bit period to adjust output skew. User data patterns can be imported or created in the built-in Editor.

Factory presets are included for commonly used logic families. Moreover, clock and data can be independently adjusted for amplitude and offset levels for both differential and single-ended outputs.

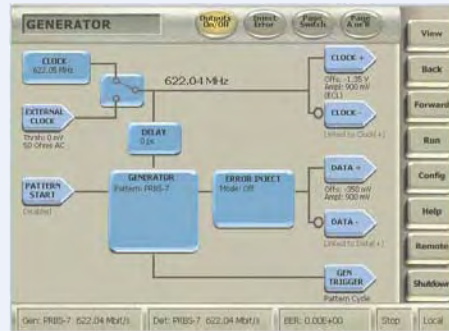

An intuitive user interface allows easy access to the impressive flexibility of the BA1500 Pattern Generator and Internal Clock Source.

## PATTERN DETECTOR

Errors are identified using bit-by-bit comparison of the incoming data stream with the expected sequence. Errors found in the received sequence can be analyzed in real time by the internal processor and/or recorded to the internal hard disk drive for later analysis or archive. The receiver will automatically synchronize with one of five true or inverted pseudo-random sequences or 8-Mbit user patterns.

Differential and single-ended inputs are supported and are fully adjustable for threshold and termination, with factory presets included for common logic families. Auto Scale can find eye center in under two seconds.

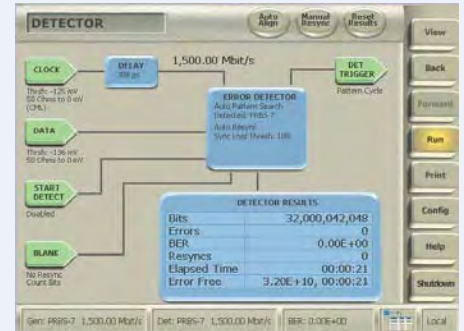

Differential and single-ended inputs are supported and adjustments for threshold level and termination voltage are allowed. Convenient logic family name setups can also be used.

## USER PATTERN EDITOR

User data patterns for the generator and detector pattern memories can be created or changed using the built-in pattern editor. Users can capture data into the pattern editor from the error detector input and create reference patterns. The pattern editor supports PRBS keywords, repeat loops, and variable assignments. Users can work in either hexadecimal, decimal, or binary.

Pattern files are stored on the BA1500's WindowsNT file system and can be imported or accessed through the provided network interface. Patterns can easily be shared between BA1500s.

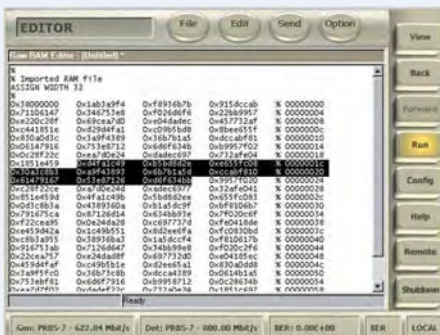

This example user data pattern was captured from the incoming data stream and then altered manually before being sent to the pattern generator as the output data sequence.

## ERROR LOG

A common application for BER monitoring requires logging error measurements and other significant events during an extended test. The BA1500 has a built-in logging feature that can be set to log BER values worse than a programmable threshold at an interval set by the user. Along with monitoring the BER value, other events including synchronization loss or settings changes are also logged.

Log files can be printed or archived and are an easy way to validate system performance or to quickly see what time errors came in.

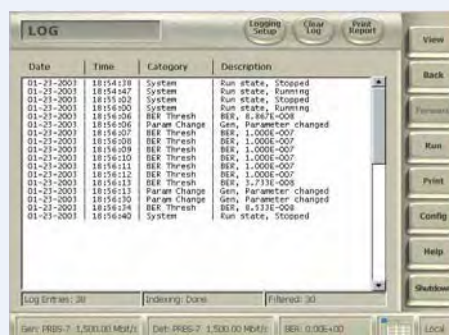

The user interface for BER logging is very straightforward. Users set the BER threshold and define what to log. The logging interval is the same interval used when measuring BER in the Detector View.

## BASIC BER STATISTICS

Error Location Analysis is the patented method of allowing the available computer processing power to study the exact bit locations of errors found during a test. With the exact bit locations, BitAlyzer can uncover error dependencies and correlations far better than when using simple error rates.

Tabular results of separate bit and burst error statistics are also monitored in the BA1500, giving the user convenient access to the number of burst events as well as error counts and rates. All error location analysis data can either be analyzed in real time or be recorded to an internal hard disk drive for later analysis or archive. The Analysis Engine has controls to allow setting filenames, error recording modes, and other settings.



The individual error rates and counts for bit versus burst errors are displayed on the Basic BER view. This simple separation can focus debugging efforts in the right area.



## STRIP CHART OF BER

Trends are very important when studying error rates. Strip charts have commonly been used to monitor measurements versus time. The built-in Strip Chart view on the BA1500 allows users to watch bit, burst, and total error rates versus time. The speed of the time axis can be set by adjusting the number of bits to be included in each bit error rate measurement. Additionally, the zoom level of the display can be set.

Repetitive errors that occur at low frequencies can be isolated with this view. For example, a burst of errors that happens every 6 seconds would be easy to spot. Strip charts also work on live or recorded error data sets.



Bit error rate trends are easily seen on a Strip Chart. Thermal cycling or changing conditions that affect communications can be tracked.

## ERROR FREE INTERVALS

Error Free Interval analysis shows how often different error free intervals have occurred in the system under test. Error free intervals that occur more often than others indicate systematic, rather than random, error behavior. At the same time, the length of a repetitive error free interval points to the frequency of interference, giving an excellent clue as to what might correlate to the unwanted errors.

Error free interval information can accumulate very quickly, so it does not take a lot of data or long tests to isolate error interferences. The BA1500's Error Free Interval analyzer can be set to study short or long error free intervals by adjusting the starting and stopping point of the histogram view.



Error free intervals that are repetitive are a sure sign of a systematic error. Finding spikes such as these during a measurement can quickly indicate the interfering frequency.

## PATTERN SENSITIVITY

The Pattern Sensitivity analysis on the BA1500 is an outstanding way of identifying data-dependent errors. This histogram shows the number of errors for every bit position of the test pattern used. Test patterns can be either the built-in PRBS patterns, or user-defined patterns. The cursors can be used to find the data values at and around the locations of pattern-dependent errors.

Extended tests with long PRBS patterns may fail because of a few errors. By using this analysis, it is easy to see if all the errors were due to the same bit sequence in the test pattern or were randomly distributed in the pattern.

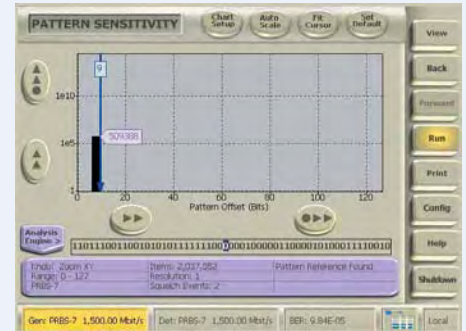

In this case, a 127-bit PRBS7 pattern was used and the detected errors correlated strongly to the data pattern. Notice the NRZ data display below the histogram that shows the highlighted data bit values at the cursor location.

## BURST LENGTH HISTOGRAM

Bit and Burst errors are typically caused by different physical phenomena. The BA1500 can measure burst error lengths up to 32,000 bits and show them in a histogram, allowing the user to quickly distinguish between error types. Users define the requirements that must be met to have a burst error. Burst length histograms are helpful as signatures for "normal" operation as well as when designing Error Correction Coding systems.

Digital processing errors will often cause a repetitive error length, while interference will often have some variation in error length. This analysis is often used with the Error Free Interval analysis to get a better understanding of both the size and frequency of errors.

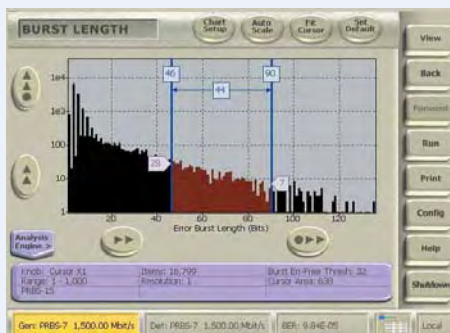

This is a typical burst length histogram in a Viterbi-protected communications channel. Cursors can be used to measure the number of bursts.

## ERROR CORRELATION

Finding correlations between system architectures or physical happenings and bit error statistics is the key to identifying the cause of many errors. The techniques in Error Location Analysis are designed to find these correlations. The Correlation analysis on the BA1500 lets users set a block size as either a fixed number of bits (e.g., a data bus width or a packet size), or as an interval defined by an external Marker input (e.g., a sector Marker on a disk drive, or a rotation Marker in an engine), to see how errors correlate to these blocks.

When all bit positions within the block size have an equal number of errors, then no correlation is found; however, if specific offsets within the block have abnormally higher error rates, then a correlation exists.

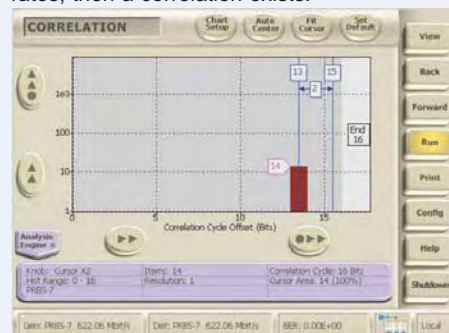

When testing MUX/DEMUX circuits, correlation to the multiplexer width can show if errors happen in the serial domain or in the parallel domain.

## BLOCK ERROR ANALYSIS

Many popular systems have performance that is more related to block error rates rather than bit error rates. The BA1500 allows the user to define a block size to display a histogram of the number of times blocks occur that have various numbers of errors in them.

Cursors can conveniently be used to find out how many blocks have occurred with more than some specific number of errors inside. The maximum block size is 4 Billion bits, making this a very powerful analysis for common block sizes.



Block error statistics are often more important to system operation than exact bit error measurements. Block sizes can be adjusted and histograms show how many times blocks occur with different numbers of errors in them.

# BA1500PL - Physical Layer (OPTION)

## EYE DIAGRAM

The Eye Diagram display is part of the BA1500 Physical Layer option. This display shares the same sampling electronics as the BER function and provides convenient eye diagrams without the need for swapping cables among instruments. The unique sampling technique used on the BA1500 provides rapid results, accumulating eyes many times faster than traditional oscilloscopes.

Automatic measurements of rise/fall times, jitter, amplitude, noise levels, and eye opening ratio are provided. Users can pan or zoom around the eye diagram to understand the exact behavior of the signal being used for bit error rate testing. The eye display shows the combination of effects from the user's signal and the BER decision circuit.

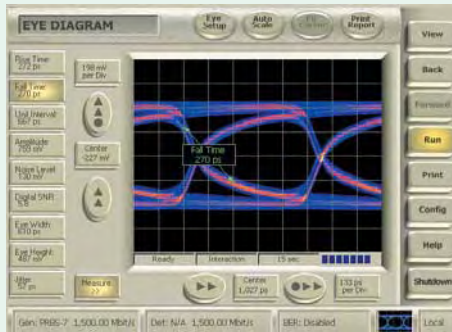

The optional Eye Diagram can be used to visually check the data input waveform quality before bit error rate tests are performed.

## MASK TEST

Eye mask testing is a part of the BA1500 Physical Layer Test option. Fast eye mask testing is a key element in test productivity. Common oscilloscope methods operate at a fixed effective sampling rate requiring mask tests to run for many, many seconds. By using BER-based methods, mask perimeters inside, above, and below the eye can be tested to far greater confidence in a few seconds.

Standard mask templates are available and the built-in editor can be used to create custom ones. Masks can also be automatically created from the BER contour analysis, allowing users to create a golden mask at a prescribed BER level. Masks can be scaled and repositioned.



Industry standard and custom masks are tested many times faster using BER-based methods built into the BA1500.

## Q-FACTOR ANALYSIS

The Q-Factor analysis is part of the Physical Layer Test option. Q-factor is to the amplitude domain what jitter is to the time domain. Q-factor is a measure of the signal-to-noise ratio of the amplitude. It says how clean the vertical eye opening is. This relates to how easily you will be able to make a 1 or 0 logic decision.

The BA1500 can do this most efficiently because of its naturally high sample rate but, most importantly, it can do it for only those waveform transitions that are nearest to the middle of the eye—the ones that would be first to be mistaken and cause bit errors.

The results of Q-factor analysis show the best predicted BER value expected, along with the optimum decision level voltage.

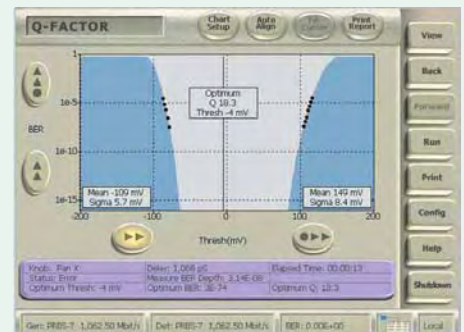

This Q-factor display was done in 13 seconds. The best decision level is shown by the cursor. Note this is not in the center of the opening, as the voltage rail around 100 mV has a wider standard deviation.

## BER CONTOUR

Bit Error Rate Contour measurement is part of the BA1500 Physical Layer option. This analysis computes the bit error rate around the perimeter of the eye opening and fits these results to the expected bit error rate response curves predicted by additive noise. The depth of the contours can then be extrapolated to lower levels than the actual measurement would allow.

BER contours are used to identify how much headroom may be present in a system after considering the amount of decision point variation that might occur. BER contours can also be exported as "golden" masks for mask testing against a known good sample.

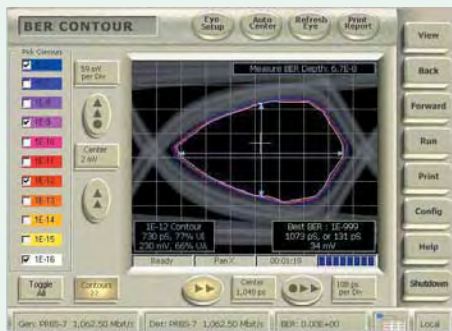

The accuracy of the BER contour improves as the test runs longer. This example took 1.5 minutes to collect. The best predicted BER and sampling location are also shown.

## JITTER PEAK

Jitter testing is part of the BA1500 Physical Layer Test option. It provides Random Jitter (RJ), Deterministic Jitter (DJ) and Total Jitter (TJ) measurements automatically, using the fast BER-scan technique. Jitter measurement accuracy is a function of the sample size used, and no competing jitter measurement technique can match the data gathering efficiency of using BERT scan data. More comprehensive BER measurements mean that there are more significant data points to use when extrapolating BER to make precise jitter measurements.

The left-hand and right-hand sides of the jitter distribution are measured separately. The center "green" area shows the deterministic jitter between the two outermost Gaussian distributions.

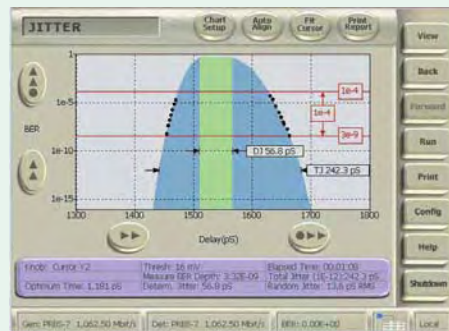

To get better results, BER data above 1e-4 BER are not used when predicting deep BER values. The longer the test runs, the more precise the measurements become.

The analysis options, including BA1500PL, BA1500FEC, and BA1500MAP, can be added to your analyzer in the field.



## FORWARD ERROR CORRECTION EMULATION

Forward Error Correction Emulation analysis is an option on the BA1500. Because of the patented error location ability of the BA1500, the BitAlyzer knows exactly where each error occurs during a test. By emulating the memory blocks typical of block error correcting codes such as Reed-Solomon architectures, bit error rate data from uncorrected data channels can be passed through hypothetical error correctors to find out what a proposed FEC approach would yield.

Users can set up error correction strengths, interleave depths, and erasure capabilities to match popular hardware correction architectures.

One-dimensional correctors allow users to set the number of symbols in an FEC block and the number of possible corrections. One-dimensional correctors can be preceded by a two-dimensional interleave, allowing improved burst error correction capability.

Two dimensions of correction can also be used to implement product-array correctors. In this case, the user specifies the number of rows and columns in the product array, along with the correction strength in both dimensions. As errors are found during the test, they are placed into the emulating table according to the interleaving configuration and, as the table fills, each enabled corrector is checked for cases where the number of errors exceeds the correction strength in any FEC codeword.

In the case of two-dimensional correctors, users can also set a configuration to use inner code failures as an outer code erasure. In this mode, single large burst correction capability can be doubled.

During FEC processing, users can see the number of times each code is used and the number of failures. Code efficiency is calculated and displayed as well.

Using the FEC analysis tools of the BA1500 on a digital channel enables FEC designers to tune the architecture for the actual error statistics present in the channel. If a channel suffers from pattern sensitivity or burst interferences, then these conditions will be presented to the FEC exactly. This is significantly better than software error correction simulations that often base their errors on white noise.

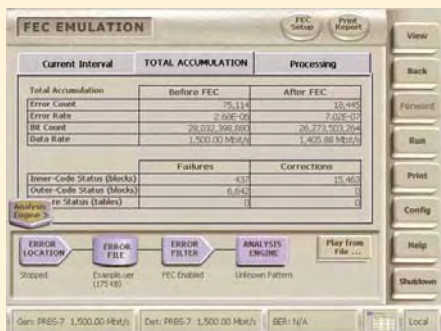

FEC Parameters are defined and can be used on live or recorded error data sets. Many different FEC architectures can be tested quickly on a single error data set.

## 2-D ERROR MAPPING

2-D Error Mapping is an option on the BA1500. This analysis creates a two-dimensional image from errors found during the test. Users specify a blocking factor, often chosen based on architectural parameters of the communications system or physical interactions.

The Error Map is a vertical raster-scan image where errors cause pixels to illuminate on the display. Errors that are from bursts are shown in a different color to allow easy visual separation of burst and non-burst errors.

Blocking factors may correspond to any size, including packet sizes, multiplexer widths, or interleave depths. Blocking factors can also be determined by external Marker signals. For instance, Index Markers from rotating disk drives can be used to make 2-D maps that show repeating reads of a disk cylinder across the display. Errors repetitively found at the same location on the disk would cause horizontal streaks in the error map.

Error mapping based on packet size or multiplexer width can show if errors are more prone to particular locations in the packet or particular bits in the parallel bus connected to the multiplexer. This visual tool allows for human eye correlation, which can often illuminate error correlations that are otherwise very difficult to find—even with all the other error analysis techniques.

Error maps can be quickly panned and zoomed throughout hours' worth of data collection. Cursors define regions, and the number of errors found inside the region is displayed. This tool provides the ultimate in visualizing how errors occur in systems.

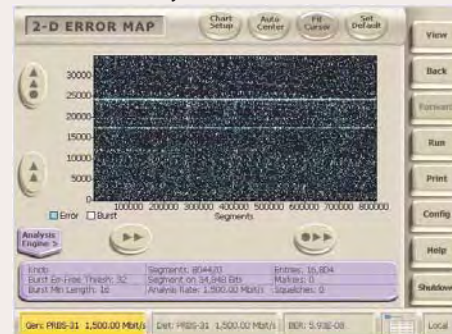

2-D Error Maps conveniently show hours or microseconds of data collection. Blocks of user data are lined up column-by-column to show error correlations.

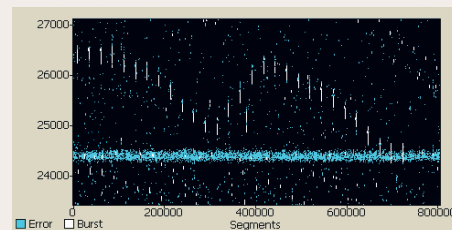

Burst and Non-Burst errors are shown in different colors. In this display, a background burst problem is superimposed on other non-burst error types. A distinct non-burst error problem exists around 24,500 bits into the packet.

## RACK MOUNT

For applications that require it, the BA1500 can be conveniently rack-mounted. The attractive brushed-aluminum rack-mount kit includes slides so that the unit can easily be pulled out from the rack.

Additionally, there is an access panel below the front of the unit that can be removed to allow convenient cabling access from inside the rack.

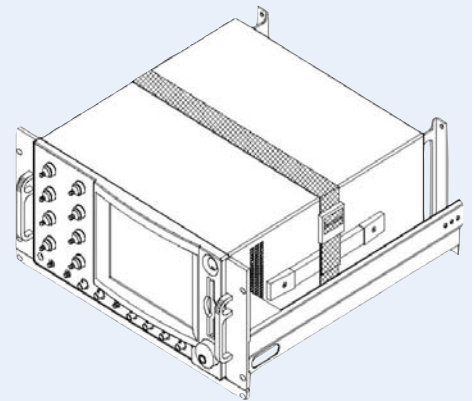

## EXTENDED WARRANTY

The Extended Warranty option adds a two-year extension to the standard one-year product warranty. All warranties include both hardware repair and software updates.

System repair or replacement is at SyntheSys Research's discretion. All repairs are performed at our Menlo Park facility. The warranty includes the cost of ground freight for return shipment. Extended warranties must be ordered within one year of initial delivery.

# New Technology in the BitAlyzer1500

## PATTERN SYNCHRONIZATION

The BA1500 supports synchronizing to both PRBS and user-defined patterns (up to 8 Mbits). Unlike other BER testers, user-defined patterns can be synchronized using two methods—one for speed and one for accuracy. For speed, user-pattern synchronization can be done by learning a repeating pattern from the incoming data. This typically takes only a few passes through the user pattern to gain synchronization, and is typically done fast enough to allow user-defined patterns during fiber recirculating loop experiments, or other applications where fast resynchronization is required. For accuracy, the BA1500 can be pre-loaded with the expected user pattern such that a hardware-accelerated search can be done to find synchronization.

## EXTERNAL CONTROL OF PATTERN

### GENERATOR AND ERROR DETECTOR

Often BER experiments require gating error measurement, precise timing of resynchronizations and bursty packet-like data. The BA1500 has user Blank inputs to gate where errors are counted and to control external resynchronization. Marker signals can be provided to customize analysis results for specific applications.

Unique to the BitAlyzer family, the pattern generator can be externally triggered to restart the pattern sequence. This allows transmitting packet-type data under external control, or synchronizing multiple pattern generators.

## DIFFERENTIAL INPUTS

Many modern high-speed communications systems employ differential signaling to improve common-mode noise rejection. For this reason, it is important to make bit error rate measurements using a true differential receiver. At the same time, variable threshold for logic decisions is also a must for analysis techniques such as jitter measurements, eye diagrams, and mask tests.

The BA1500 has a new input technology that allows variable thresholds with settable DC termination voltages on differential input signals at very high data rates, while maintaining excellent return loss performance.

## AUTOMATIC DELAY CALIBRATIONS

Precise variable delay settings are critical to analysis such as jitter, mask testing, and eye diagrams. Past variable delay technology has either been slow or was not able to maintain delay calibrations over long time periods or at different frequencies.

The BA1500 includes a new technology for automatically calibrating the entire variable delay element with sub-picosecond resolution capability in less than a second. Because this is so fast, it is convenient to allow re-calibration when changes in temperature or frequency occur that might cause delay error.

## AUTOMATIC EYE MASKS

Mask templates for eye diagram testing often come from industry standard definitions; however, these masks are usually only good for go/no-go type testing. More precise masks that circumscribe the details of a particular device output waveform can be used to monitor minor variations to production practices.

The BA1500 Bit Error Rate Contour analysis is the first bit error rate tester that automatically exports eye diagram masks created from bit error rate data taken around the perimeter of the eye.

## ERROR LOCATION ANALYSIS

The BitAlyzer1500 is a member of the BitAlyzer family of bit error rate testers that have the added capability to study and archive the exact bit location of each error in the data stream. SyntheSys Research pioneered this technique to get more information about failures during bit error rate tests.

This proven method has been used in applications over the last 10 years to isolate error causes, find correlations, identify interference and, in general, to solve problems. Error location analysis can be done easily using the same test setups typically used for regular bit error rate testing.

## EYE DIAGRAMMING

Eye Diagramming inside bit error rate testers is another invention from SyntheSys Research, and the BA1500 is the first instrument available with this feature. Eye diagrams are efficiently collected and correspond precisely to the bit error rate test data taken with the same device.

Pixel-by-pixel sampling, achieved by quickly positioning the decision window voltage and time to each pixel in the display, creates eye diagrams.

## OUTPUT DRIVERS

The output drivers in the BA1500 come from technology developed for 10 Gbit/sec communications systems. Precise designs provide for low jitter outputs with fast edge rates, and allow flexibility to change voltage amplitudes and offsets to cover all popular logic families. As current sources, the BA1500 user interface allows setting the destination impedance and termination voltage to maintain calibrated voltage swings.

## COMPARING SAMPLING RATES WITH OSCILLOSCOPES

Modern repetitive sampling oscilloscopes typically used for physical layer measurements offer basic sampling rates of 40–100k samples per second. This impacts the amount of data in histograms used to make jitter measurements and eye diagrams used during mask testing.

Techniques based on bit error rate measurement can collect data at the bit rate of the data stream and can place the sampling point exactly at a location where data collection is desired. For example, by efficiently moving the decision point to all locations inside a 400 x 250 pixel eye diagram, samples can be collected where each pixel has over 10,000 samples each second in Gbit/sec links—faster links collect even faster.

Oscilloscopes must distribute their samples across all time positions, allowing each vertical column to collect only a fraction of the samples (e.g., 1/400 in this example). That makes 100 to 250 samples per second for each time position.

Data collected to make jitter measurements are similarly affected. Histograms on oscilloscopes collect the most data when the histogram window is large compared to the view. In typical histogramming applications, a histogram may accumulate 2–20k samples per second. This means that the “tails” of the measured probability populations only extend down to error rates of 10e-3 or 10e-4 per second.

Bit error rate testers running at 1 Gbit/sec measure 1e-7 or 1e-8 bit error rates each second, even considering processing overheads.

In all of these cases, the sampling rates of BitAlyzer technology enable data collection at orders of magnitude faster than other approaches.

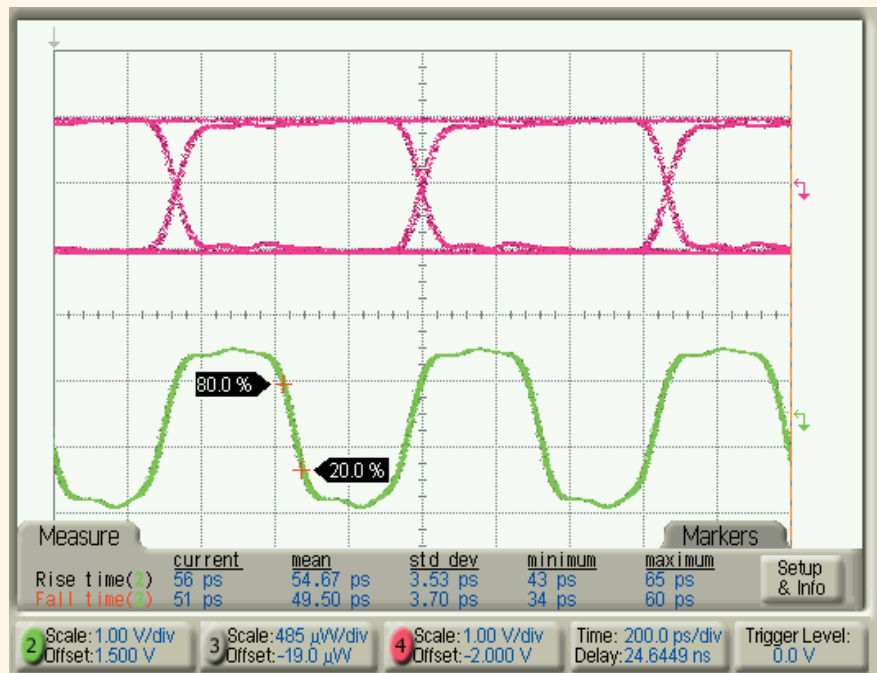

Typical Data and Clock outputs of the BA1500 at 1.5 Gbit/sec with 2 V p-p Amplitude settings.

## GENERATOR

Maximum Frequency	..... 1500 MHz
Minimum Frequency	.....
Internal Clock	..... 800 kHz
External Clock	..... 100 kHz
Ext. Clock/Pattern Start	..... SMA
Configuration	..... Single-ended
Threshold (see NOTE)	..... -2 V to +4 V
Termination (see NOTE)	..... -2 V to +3.3 V
Clock/Data Output	..... SMA
Configuration	..... Differential
Amplitude (see NOTE)	..... 70 mV to +2 V

Offset (see NOTE)	..... -1.85 V to +3.85 V
Logic Families	..... PECL/LVPECL/LVDS LVTTTL/CML/ECL
Rise/Fall	..... <100 ps (80 ps typ.)
Delay Range	..... 30 nsec or 1 UI
Delay Resolution	..... 0.1% UI or 1 psec
Trigger Output	..... BNC
Type	..... CLK/32 or Pattern
Pattern Position	..... Programmable
Amplitude	..... > 1 V
A/B Pattern Pg. Switch	..... BNC
Threshold	..... TTL

## Data Types

Pseudo-Random	..... $x^7 + x^6 + 1$ $x^{15} + x^{14} + 1$ $x^{20} + x^{17} + 1$ $x^{23} + x^{18} + 1$ $x^{31} + x^{28} + 1$
User-Defined	..... 96 bits - 8 Mbit 2-4 Mbit A/B Pages 32-bit word size
Error Insertion	.....
Length (bits)	..... 1,2,4,8,16,32,64,128
Frequency	..... Single or repetitive

## DETECTOR

Maximum Frequency	..... 1500 Mbit/sec
Minimum Frequency	.....
BER Measurements	..... 100 kbit/sec
Auto-Optimize Eye	..... 70 Mbit/sec
Physical Layer Tests	..... 70 Mbit/sec
Clock/Data Inputs	..... SMA
Configuration	..... Differential or Single
Threshold (see NOTE)	..... -2 V to +4 V
Termination (see NOTE)	..... -2 V to +3.3 V
Delay Range	..... 30 nsec or 1 UI
Delay Resolution	..... 0.1% UI or 1 psec
Sampling Edge	..... Rising or Falling Clock
Sensitivity - single	..... 60 mV p-p (typ.)
Sensitivity - diff.	..... 40 mV p-p (typ.)
Start Detect	..... SMA
Configuration	..... Single-ended
Threshold (see NOTE)	..... -2 V to +4 V
Termination (see NOTE)	..... -2 V to +3.3 V
Function	..... Triggers data grab
Trigger Output	..... BNC
Type	..... CLK/32 or Pattern
Pattern Position	..... Programmable
Amplitude	..... > 1 V
Error Output	..... BNC
Function	..... 32-bit pulse at error
Amplitude	..... > 1 V
Marker Input	..... BNC
Threshold	..... TTL

Function	..... Error Analysis locator
Max. Frequency	..... 4 kHz recommended
Blank Input	..... BNC
Threshold	..... TTL
Function	..... Ignore errors at active
Resynchronization	..... Opt. triggered by edge
Minimum Resolution	..... 32 bits
Data Types	.....
Pseudo-Random	..... $x^7 + x^6 + 1$ $x^{15} + x^{14} + 1$ $x^{20} + x^{17} + 1$ $x^{23} + x^{18} + 1$ $x^{31} + x^{28} + 1$
User Defined	..... 96 bits - 8 Mbit 32-bit word size
Resynchronization	.....
Manual	..... Pushbutton or Blank
Automatic	..... Prog. Error Threshold
User Grab	..... Find repeating pattern
User Shift	..... HW Pattern Search
Data Capture	..... Up to 8 Mbit capture
Measurements	..... BER, Bits, Resyncs PG/ED Clock Freq

## Views

Home View	..... Starting Page
Generator	..... Generator Settings
Detector	..... Detector Settings
Editor	..... Edit patterns, masks
System	..... Utility Tools
Log	..... Long-term BER log
Error Analysis	..... Standard
Basic BER	..... Table of BER stats
Burst Length	..... Hist. of Burst Size
Error Free Interval	..... Hist. of intervals
Correlation	..... Errors positions Hist.
Pattern Sensitivity	..... Errors within Pattern
Block Mode	..... Errors per Block Hist.
Strip Chart	..... BER vs. Time Chart
Physical Layer Test	..... <b>OPTIONAL</b>
Eye Diagram	..... Display eye diagram
BER Contour	..... Map BER around eye
Mask Test	..... Perform Mask Tests
Jitter Analysis	..... DJ/RJ/TJ Jitter Meas.
Q-Factor Analysis	..... Setup & Display Q
Error Location Capture	.....
Live Analysis	..... Continuous
Error Logging Cap.	..... Max. 2 GB file size
Error Events/Sec	..... 10,000
Max. Burst Length	..... 32 kbits

## GENERAL

TFT Display	..... 640 x 480 VGA
Touch Sensor	..... Analog Resistive
Self-Test	..... On power-up
Processor	..... 500 MHz Pentium (or equivalent)

Floppy	..... 1.44 MByte
HDD	..... 20 GByte
Keyboard	..... Micro
DRAM	..... 64 MByte
Operating System	..... WindowsNT
Printer Port	..... Centronix
Monitor Output	..... DB-15 VGA
Mouse	..... PS/2

Remote Control	..... IEEE-488 or TCP/IP
Network Interface	..... 100 MB Ethernet
Weight	..... 36 lbs
Power	..... 270 watt, 90-240 VAC
Size	..... 8.6" x 16.5" x 19.25"

## NOTICE

Contact SyntheSys Research for limitations to Q-Factor, BER Contour, and Jitter Peak analyses when using very clean signals.

Limitations exist when setting various output amplitudes and offsets. The listed logic families are all within range. See factory for graphs of allowed combinations.

Limitations exist when setting different input terminations and input thresholds. The listed logic families are all within range. See factory for allowed combinations.

Specifications are for operation at 25 degrees C after 20-minute warm-up period.

SPECIFICATIONS SUBJECT TO CHANGE.

PATENTS GRANTED AND PENDING





**WORLD DISTRIBUTION OFFICES**

*SyntheSys  
Research has  
distributors  
worldwide to  
support you  
with your bit  
error rate  
testing needs.*

**ORDERING INFORMATION**

- BA1500 ..... 1.5 G Pattern Generator, Error Detector, Error Analysis, and Built-In 0.8 MHz – 1500 MHz Clock Source
- BA1500PL ..... Physical Layer Test Suite option, including: Eye Diagram, Mask Test, BER Contour, Q-Factor, Jitter Peak
- BA1500FEC ..... Forward Error Correction Emulation Option
- BA1500MAP ..... Error Mapping Analysis Option
- BA1500RACK ..... Rack Mounting Kit
- BA15003YR ..... Add 2 Years to Standard 1-Year Warranty

**WARRANTY**

All equipment is fully warranted for one year. This includes hardware repair or replacement, at SyntheSys Research's discretion, and software updates. Necessary repairs are performed at the Menlo Park, California factory.

**THE COMPANY**

Founded in 1989, SyntheSys Research, Inc. is a manufacturer of test instruments for analyzing a variety of digital communications channels. From fiber optics to satellites, hard disks to laser communications, and HDTV to digital television, the company has pioneered innovative techniques into award-winning, user-friendly instruments. SyntheSys Research is driven by the goal of creating quality products needed by industry professionals.

**SYNTHE SYS**  
**RESEARCH, INC.**

3475-D Edison Way  
Menlo Park, CA 94025 U.S.A.  
Voice (650) 364-1853  
Fax (650) 364-5716  
info@synthesysresearch.com  
www.synthesysresearch.com

"Windows" and "WindowsNT" are Registered Trademarks of Microsoft Corporation.