

SIGNAL SOURCES

Synthesized Signal Generators

6010A/6011A

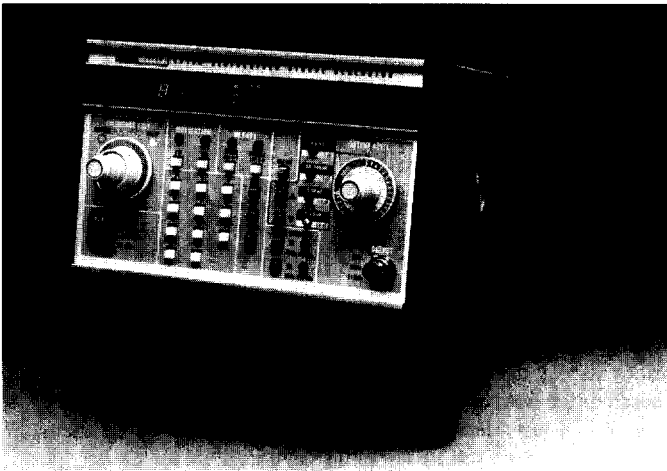

6010A

6010A Signal Generator

The Fluke 6010A Signal Generator is a light-weight micro-processor-controlled frequency synthesizer/signal generator suitable for portable, bench-top, and systems applications. It uses an internal 10 MHz frequency source to indirectly synthesize output frequencies from 10 Hz to 11 MHz with 0.1 Hz resolution to 110 kHz and 10 Hz resolution to 11 MHz. It can be slaved to an external 10 MHz reference. Output range is 0.25 mV to 5V rms into 50 Ω . Rotary knob adjusts over 26 dB range. Keyboard selects one of four attenuator settings providing up to 60 dB of attenuation.

A front panel keyboard is used to enter output frequencies. Data is displayed as it is entered, and optimized for maximum resolution when a frequency range is selected. Thus entering 0.1 MHz, 100 kHz or 100,000 Hz results in the same output resolution. An easy-to-read seven-digit LED readout plus a range annunciator display the optimized output frequency. Fixed format entries can be made by energizing a range override feature.

Entered frequencies can be stored for future use in any one of ten locations by using the keyboard in conjunction with a store function. Once stored, any one of the 10 frequencies can be randomly selected using a recall function. This feature simplifies not only manual operations involving several frequencies, but also the programming necessary for systems applications.

Frequency selection and alteration are enabled by a unique frequency edit feature. A dual-concentric rotary knob allows any displayed frequency decade to be selected and incremented or decremented. Complete carry-over and borrow capability is included. Recalled frequencies can be modified without changing the original frequency stored in memory.

For systems applications the 6010A is equipped with a seven-line ASCII, byte serial, TTL compatible interface. Both free-form and fixed-form frequency data is acceptable. Optional interfaces are available. These include the IEEE-488 Interface Option (-05) and the EIA Standard RS-232-C Interface option (-06). For 6010A programming information request Application Bulletin No. 21.

Options

A complete line of options and panel mounting accessories are available for use with the 6010A. Refer to the 6010A specifications and price list for a detailed description of each option.

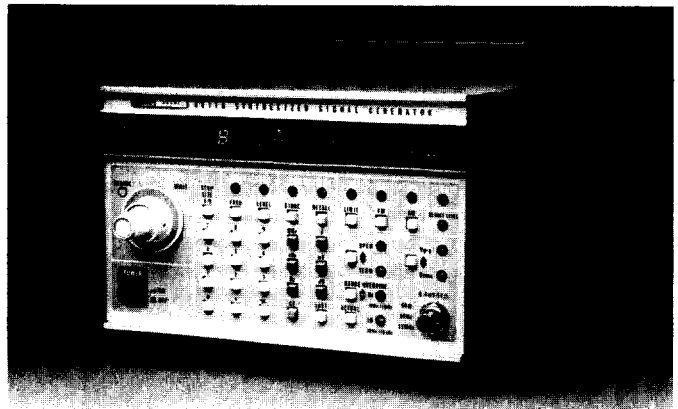

6011A

6011A Signal Generator

The 6011A performs the functions of an oscillator, counter, and level meter over a range of 10 Hz to 11 MHz, with amplitudes ranging from 0.4 mV to 5V rms and -55 dBm to +27 dBm. Designed for portable, bench-top, and systems applications, it uses a highly stable internal 10 MHz frequency source to indirectly synthesize output frequencies from 10 Hz to 11 MHz with 0.1 Hz resolution to 110 kHz and 10 Hz resolution to 11 MHz. When desired, it can be slaved to an external 10 MHz reference. Output level is digitally controlled and can be selected in terms of V, mV or dBm. Additional output flexibility is added by the ability to select volts peak-to-peak or volts rms into an open-circuit or 50 Ω termination. Maximum obtainable output voltage is 28.28V p-p.

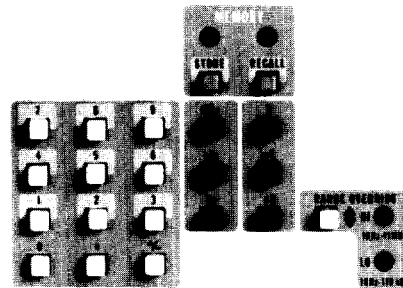

Data Entry

A front panel keyboard permits free-form entry of both frequency and output level. Up to seven digits of frequency data can be entered in terms of Hz, kHz or MHz. Data is displayed as it is entered, and optimized by the microprocessor for maximum resolution when a frequency range is selected. Thus, entering 0.1 MHz, 100 kHz, or 100,000 Hz results in the same output resolution. Fixed format entries can be made by enabling a range override feature. Up to four digits of output level data can be entered in terms of V, mV or dB. As with frequency, entered output level data is displayed, and optimized when the output range is selected.

Entered frequency and output level data can be stored for future use in any one of nine locations (1-9) by using the keyboard in conjunction with the memory store function. Once stored, any one of the nine stored conditions may be randomly selected using the memory recall function. This feature not only simplifies manual operations involving several frequencies, it also simplifies the programming necessary for systems applications.

SIGNAL SOURCES

Synthesized Signal Generators

6010A/6011A



Display

The LED display provides a visual readout of output frequency, output level and program data. As numeric program data is entered, it appears on the left half of the display and does not affect frequency or output level until a function is selected. At that time, the entered data is automatically justified for maximum resolution, and properly positioned on the frequency or output-level portion of the display. Both decimal points and range annunciator LED's are provided to complement entered data. Data entered via a remote interface is displayed in the same manner.

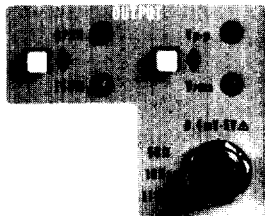

Output

The 6011A output is adjustable over a range of 0.4 mV rms to 5V rms or -55 dBm to 27 dBm. Levels may be defined in terms of volts peak-to-peak or volts rms terminated in 50Ω, 75Ω (optional) or open circuit. Output accuracy, as shown in Figure 1, is controlled to within ± 0.05 dB by an rms sensor. A standard BNC connector is used for output connections.



Level Limit

The level limit feature allows the user to establish an output-level limit in volts or power which cannot be exceeded by entry of subsequent output-level data. Thus, sensitive devices can be easily and effectively protected from accidental damage due to incorrect programming.

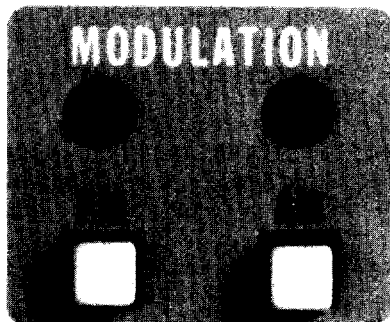

Modulation

Output signals can be amplitude modulated or frequency modulated (-03 option). In AM mode, depth of modulation is proportional to the amplitude of an external drive signal. Bandwidth of the AM input is dc to 10 kHz and maximum modulation is 90%. An input of ± 4 V corresponds to 100% modulation. Input impedance of the rear-panel AM input is 600Ω.

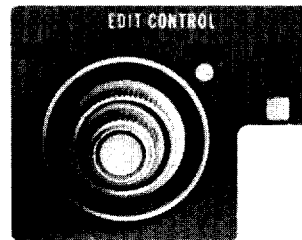

Edit Control

Entered frequency and output levels may be altered using the edit control feature. A dual-concentric rotary knob selects the decade to be modified and denotes it by intensifying the appropriate display decade. The bright digit can then be incremented or decremented with continuous carry-over and borrow capability. A step-size feature allows any increment or decrement step size from 1 through 9 to be selected via the keyboard.

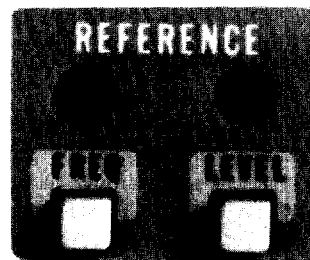

Reference

Any frequency and/or output level within the range of the 6011A may be established as a reference about which deviations can be programmed. When a reference is established, subsequent entries are added to or subtracted from that level.

To simplify use of the reference feature, the 6011A performs calculations necessary to make dB deviations about a voltage reference. Also, the memory feature can be used to store and recall up to nine frequency and output level deviations.

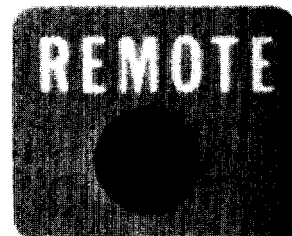

Remote

For remote applications, a seven-line, ASCII, bit-parallel interface is provided with the basic 6011A. Other standard interfaces are available as options, and include the IEEE Standard 488 General Purpose Bus Interface and the EIA Standard RS-232C Interface. All 6011A front panel controls with the exception of line power and termination conditions can be programmed using any of these interfaces. A front panel LED indicates all front panel switches are inactive due to remote operation. For detailed 6011A programming information, request Fluke Application Bulletin No. 22.

Options

A complete line of options and panel mounting accessories is available for use with the 6011A. Refer to the 6011A specifications and price list for a detailed description of each option.

SIGNAL SOURCES

Synthesized Signal Generators

6010A/6011A

6011A Frequency Response (50 Ohm)

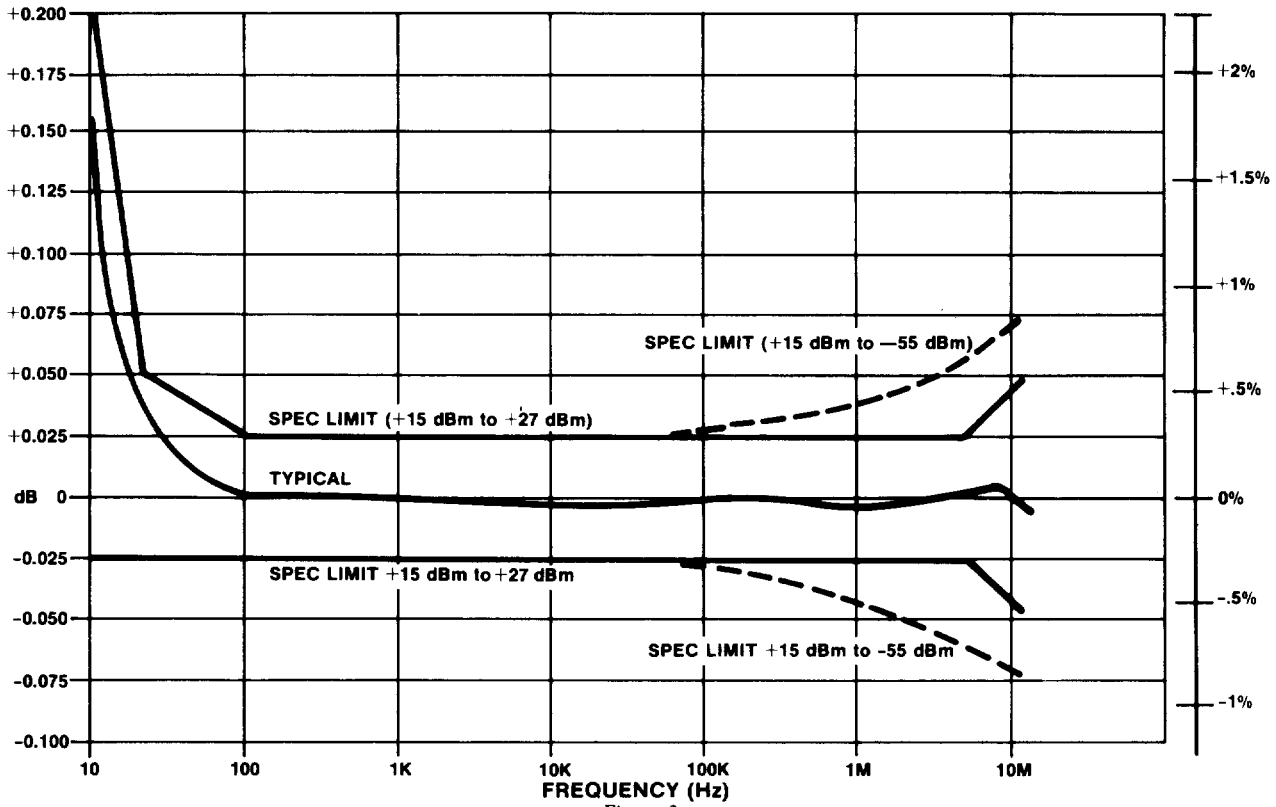

Figure 2

6011A Frequency Response Option -10 (75 Ohm)

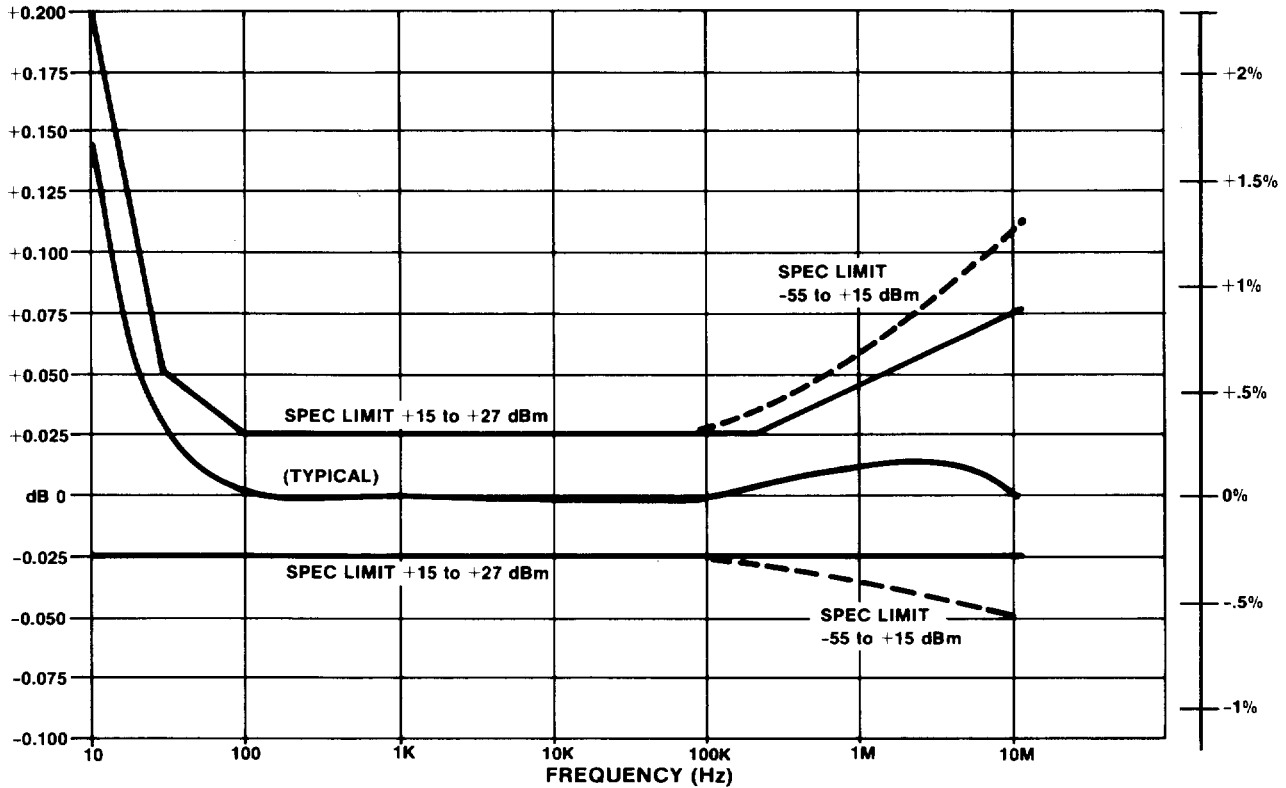

Figure 3

SIGNAL SOURCES

Synthesized Signal Generators

6010A/6011A

Specifications 6010A/6011A

PARAMETER	6010A	6011A
Frequency		
Low Range:	10 Hz to 109.9999 kHz	
High Range:	10 Hz to 10.99999 MHz	
	6010A usable to 0.1 Hz	
Resolution:	0.1 Hz in the low range 10 Hz in the high range	
Range Selection:	Automatic with manual override	
Annunciation:	Units automatically justified in the LED display to indicate maximum resolution	
Accuracy:	± 3 parts in 10^6 for one year over the temperature range of 0°C to +50°C	
Aging Rate:	< 1 part in 10^6 per day at constant temperature or 1 part in 10^6 per year	
Temperature:	< ± 2 parts in 10^6 from 0°C to +50°C (< ± 5 parts in 10^7 from 0°C to +50°C with optional high performance oscillator)	
Local Control:	Keyboard selection of numerical data, magnitude (Hz, kHz, MHz) and functions. Edit control provided for modifying entry. 6011A programmable in steps of 1 - 9.	
Frequency Display:	Seven-digit LED display of frequency set by local or remote control	
Frequency Storage:	Facility to store and recall 10 front panel control settings including frequency, attenuator and modulation	Facility to store and recall 9 front panel control settings including frequency, level, modulation, and output terminal parameters
Remote Frequency Control:	Character Serial ASCII data format. Two programming formats — fixed form and free form	
Switching and Settling Time:	Frequency settles to within 10 Hz in low range and 1 kHz in high range of final frequency in < 2 ms in fixed form	
	<10 ms in free form (excluding recall)	<34 ms in free form (excluding recall)
Spectral Purity		
Harmonics:	-50 dB from 10 Hz to 1 MHz -40 dB from 1 MHz to 11 MHz (Except -35 dB for output levels within 2 dB of max output on each attenuation range from 5 MHz to 11 MHz). Total harmonic distortion from 10 Hz to 110 kHz is <0.15% (typically 0.07%) on low range and 0.3% (typically 0.1%) on high range.	-30 dB from 10 Hz to 100 Hz -50 dB from 100 Hz to 1 MHz -40 dB from 1 MHz to 11 MHz (Except -35 dB for output levels within 2 dB of max output from 5 MHz to 11 MHz). Total harmonic distortion from 100 Hz to 110 kHz is <0.15% (Typically 0.07%) on low range and 0.3% (typically 0.1%) on high range.
Spurious:	All non-harmonically related outputs > -60 dB or -110 dBm whichever is greater.	
Signal-to-Phase Noise Ratio:	>46 dB as measured in a 30 kHz bandwidth excluding 1 Hz centered on the carrier, including the effects of the internal standard. Residual (excluding internal standard) is >50 dB down. Approximately 8 dB improvement on low range	
Phase Noise		
Spectral Density:	SSB S/N Ratio at the output measured in a 1 Hz bandwidth at max output (typical). Approx. 10 dB improvement on low range.	
	Offset Frequency	SSB S/N
	20 Hz	102 dB
	200 Hz	108 dB
	20 kHz	106 dB
	1 MHz	130 dB

PARAMETER	6010A	6011A
Amplitude		
Impedance:	50 Ω (75 Ω w/option -10)	
Range dBm:	+27 dBm to -59 dBm into 50 Ω	+26.98 dBm to -55.01 dBm into 50 Ω
volts:	5V rms to 0.25 mV rms	5.000V rms to 0.3972 mV rms
Local Control:	Rotary knob adjusts amplitude over a 26 dB range, keyboard selects one of four attenuator settings. Attenuator consists of 20 and 40 dB sections providing 0 to 60 dB of attenuation in 20 dB steps	Keyboard selection of output level in V, mV or dBm. Voltage is selectable in terms of V rms or V p-p and terminated or open circuit. Rotary knob provided for modifying entry and is programmable in steps of 1 through 9
Amplitude Maximum:	5V rms terminated +27 dBm	5.000V rms terminated 10.00V rms open circuit 14.14V p-p terminated 28.28V p-p open circuit +26.98 dBm into 50 Ω
Amplitude Resolution:	0.25V/div	Four digits resolution in dBm, V and mV
Amplitude Accuracy:	<7% of range at 25°C and 10 kHz. Attenuator error <0.06 dB/20 dB step	See Figure 1.
Frequency Response:	± 0.5 dB from 10 Hz to 11 MHz within each band	See Figure 2 and 3.
Stability vs. Temp:	± 0.25 dB, +18°C to +28°C ± 0.75 dB, 0°C to 50°C	Typical temperature coefficient is 0.003 dB/°C, 20°C to 30°C ± 0.2 dB, 0°C to 50°C
Amplitude Switching and Settling Time:		± 1 dB, 150 ms fixed form ± 0.1 dB, 300 ms fixed form ± 0.01 dB, 450 ms fixed form (Add 200 ms for free form)
Display:	Rotary knob calibrated in voltage and power. Attenuator range denoted by LED	dB: 4-digit plus sign in dBm or dB with respect to a stored dBm reference. Volts: 4-digit in V p-p or V rms; open circuit or terminated or volts or dB with respect to a stored voltage reference
AM Modulation:	Analog input can be used to provide amplitude modulation. Bandwidth of this input is 10 kHz and max modulation is 90%. Z in = 600 Ω	
	± 5 V corresponds to 100% modulation	± 4 V corresponds to 100% modulation
Remote Control:	Character serial ASCII data format. Two programming formats — fixed form and free form	
	BNC connector on rear panel will program output from 0.25V to 5V rms. +5.0V dc corresponds to 5V rms	
Remote Interfaces		
Standard:	Byte serial, bit parallel, seven ASCII-defined parallel lines, plus two handshake lines. Mating Connector Amphenol 57-30240	
IEEE Standard 488-1975 (Option -05):	General Purpose Bus Interface. Byte serial, bit parallel, seven parallel data bits, three handshake lines, plus three of five possible housekeeping lines.	
RS-232C (Option -06):	Byte serial, bit serial interface. Asynchronous data rates from 110 to 9600 baud. 32-character FIFO buffer. Voltage level interface or 20 mA current loop.	

SIGNAL SOURCES

Synthesized Signal Generators

6010A/6011A

PARAMETER	6010A	6011A
Outputs		
TTL Output:	TTL compatible square wave output (<0.5V to >2.4V p-p into 50Ω) at the synthesized output frequency.	
Reference:	Derived from the synthesizer frequency reference. 1 MHz output is standard; 5 or 10 MHz available by changing internal jumper. Output is TTL compatible square wave.	
Inputs		
External Reference:	Requires a 10 MHz TTL compatible square wave with symmetry between 40% and 60%. Internal reference is automatically selected in the absence of an external reference.	
General		
Operating Environment:	0° to 50°C, 0 to 80% RH, 0 to 10,000 feet	
Storage Temp:	-40°C to 75°C	
Power Requirements:	115/230V rms ±10%, 50 to 60 Hz, 100W. Power switch disconnects both sides of power line.	
Dimensions		
Height:	13.3 cm (5.25 in)	
Width:	21.6 cm (8.5 in)	
Depth:	48.2 cm (19 in)	
Weight:	11.4 kg (25 lbs)	

Outline Drawing

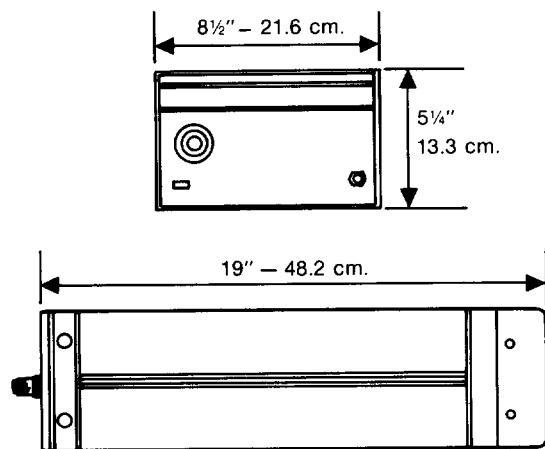

Options

High Performance TCXO Option (-01)

Frequency Accuracy: ±1.5 parts in 10⁶ for one year over the temperature range of 0°C to +50°C.

Aging Rate: <1 part in 10⁸ per 24 hours at constant temperature, or 1 part in 10⁶ per year.

Temperature Dependence: < ±5 parts in 10⁷ from 0°C to +50°C

Phase Lockable Input Option (-02)

Input Frequency: 1, 2, 2.5, 5 or 10 MHz

Input Level: >100 mV, <5V rms into 50 Ω. May be used with either the standard oscillator or the optional high performance oscillator. Locking range: ±5 parts in 10⁶ from frequency of internal oscillator.

Frequency Modulation Option (-03)

	High Range	Low Range
Deviation about dialed frequency:	±20 kHz	±200 Hz
Accuracy 0-50°C:	±1.5 kHz	±15 Hz
Rate:	dc to 10 kHz	dc to 10 kHz
Linearity at constant temp:	±1 kHz	±10 Hz
Stability at constant temp:	±400 Hz	±4 Hz
Incidental AM (typical):	<1%	<0.5%
Impedance:	600Ω	600Ω
Input:	1V for 4 kHz ±5V max.	1V for 40 Hz ±5V max.

Rear Panel Output Option (-04)

IEEE Standard 488-1975 Option (-05)

See description under Remote Interfaces

EIA Standard RS-232-C Interface Option (-06)

See description under Remote Interfaces

50 to 400 Hz Line Power Option (-07)

100V, 50 to 60 Hz Line Power Option (-08)

20-31 MHz Tracking Output Option (-09)

75Ω Output Impedance Option (-10)

Amplitude Accuracy: Same as 50Ω system

Frequency Response: 6010A, same as 50Ω system; 6011A, see Fig. 3

Price

Models

6010A Synthesized Signal Generator	\$2695
6011A Synthesized Signal Generator	4195

Options

6010/6011-01 High Performance TCXO	125
6010/6011-02 Phase Lock Input (1)	210
6010/6011-03 Frequency Modulation *(1)	550
6010/6011-04 Rear Panel Output	15
6010/6011-05 IEEE 488 General Purpose Bus Interface *(2)	295
6010/6011-06 EIA Standard RS-232C Interface (2)	295
6010/6011-07 50 - 400 Hz Line Power	160
6010/6011-08 100V, 50 - 60 Hz Line Power	NC
6010/6011-09 20 - 31 MHz Tracking Output *	35
6010/6011-10 75 Ω Output Impedance	NC

Accessories

M05-203-601 5 1/4" Rack Adapter, Offset	40
M05-203-602 5 1/4" Rack Adapter, Centered	40
M05-200-603 5 1/4" Rack Adapter, Dual	30
M00-260-610 18" Rack Slide Kit	60
M00-203-631 5 1/4" Rack Adapter w/18" slides	100

* Field installable options - order 6010/6011-03K, 6010/6011-05K, or 6010/6011-09K

(1) Cannot have -02 and -03 options together in the 6011A

(2) Cannot have -05 and -06 options together in either 6010A or 6011A.