

User's and Service Guide

Agilent Technologies 85050D 7 mm Economy Calibration Kit

This manual applies directly to 85050D calibration kits with serial number prefix 3101A. The calibration devices in this kit are individually serialized. Record the device serial numbers in the table provided in this manual (see "Recording the Device Serial Numbers" in Chapter 1.)



Agilent Part Number: 85050-90052

Printed in USA

Print Date: June 2002

Supersedes: September 1996

© Copyright 1994, 1996, 2002 Agilent Technologies, Inc. All rights reserved.

Documentation Warranty

THE MATERIAL CONTAINED IN THIS DOCUMENT IS PROVIDED "AS IS," AND IS SUBJECT TO BEING CHANGED, WITHOUT NOTICE, IN FUTURE EDITIONS. FURTHER, TO THE MAXIMUM EXTENT PERMITTED BY APPLICABLE LAW, AGILENT DISCLAIMS ALL WARRANTIES, EITHER EXPRESS OR IMPLIED WITH REGARD TO THIS MANUAL AND ANY INFORMATION CONTAINED HEREIN, INCLUDING BUT NOT LIMITED TO THE IMPLIED WARRANTIES OF MERCHANTABILITY AND FITNESS FOR A PARTICULAR PURPOSE. AGILENT SHALL NOT BE LIABLE FOR ERRORS OR FOR INCIDENTAL OR CONSEQUENTIAL DAMAGES IN CONNECTION WITH THE FURNISHING, USE, OR PERFORMANCE OF THIS DOCUMENT OR ANY INFORMATION CONTAINED HEREIN. SHOULD AGILENT AND THE USER HAVE A SEPARATE WRITTEN AGREEMENT WITH WARRANTY TERMS COVERING THE MATERIAL IN THIS DOCUMENT THAT CONFLICT WITH THESE TERMS, THE WARRANTY TERMS IN THE SEPARATE AGREEMENT WILL CONTROL.

Assistance

Product maintenance agreements and other customer assistance agreements are available for Agilent products.

For any assistance, contact Agilent Technologies. Refer to [Table 5-1 on page 5-4](#).

1. General Information

Calibration Kit Overview	1-2
Kit Contents	1-2
Calibration Definitions	1-3
Incoming Inspection	1-3
Serial Numbers	1-4
Recording the Device Serial Numbers	1-4
Calibration Kits Documented in This Manual	1-4
Calibration Kit History	1-4
85050D Kits with Serial Prefix 3027A	1-4
Preventive Maintenance	1-5

2. Specifications

Environmental Requirements	2-2
Temperature—What to Watch Out For	2-2
Mechanical Characteristics	2-3
Pin Depth	2-3
Electrical Specifications	2-6
Certification	2-6

3. Use, Maintenance, and Care of the Devices

Electrostatic Discharge	3-2
Visual Inspection	3-3
Look for Obvious Defects and Damage First	3-3
Inspect the Mating Plane Surfaces	3-3
Cleaning Connectors	3-4
Gaging Connectors	3-6
Connector Gage Accuracy	3-6
When to Gage Connectors	3-6
Reading the Connector Gage	3-7
Gaging Procedure	3-8
Connections	3-10
How to Make a Connection	3-10
How to Separate a Connection	3-12
Handling and Storage	3-12

4. Performance Verification

Introduction	4-2
How Agilent Verifies the Devices in Your Kit	4-2
Recertification	4-3
How Often to Recertify	4-3
Where to Send a Kit for Recertification	4-3

Contents

5. Troubleshooting

Troubleshooting Process	5-2
Returning a Kit or Device to Agilent	5-4
Where to Look for More Information	5-4
Contacting Agilent	5-4

6. Replaceable Parts

Introduction	6-2
--------------------	-----

A. Standard Definitions

Version Changes	A-2
Standard Class Assignments	A-3
Blank Forms	A-6
Nominal Standard Definitions	A-9
Setting the System Impedance	A-9
Blank Forms	A-13

1 General Information

Calibration Kit Overview

The Agilent 85050D 7 mm calibration kit is used to calibrate Agilent network analyzers up to 18 GHz for measurements of components with 7 mm connectors.

The standards in this calibration kit allow you to perform simple 1- or 2-port and TRM (thru–reflect–match) calibrations.

This manual describes the 85050D calibration kit and provides replacement part numbers, specifications, and procedures for using, maintaining, and troubleshooting the kit.

Kit Contents

The 85050D calibration kit includes the following items:

- user's and service guide
- open, short, and broadband load terminations
- 3/4 in, 135 N-cm (12 in-lb) torque wrench for use on the 7-mm connectors
- a data disk that contains the calibration definitions of the devices in the kit for the 8510 systems and the 872x series
- a data disk that contains the calibration definitions of the devices in the kit for the PNA series

Refer to [Table 6-1 on page 6-2](#) for a complete list of kit contents and their associated part numbers.

Opens and Shorts

The opens and shorts are built from parts that are machined to the current state-of-the-art in precision machining.

The shorts have a one-piece shorting plane that combines the inner and outer conductors. The construction provides for extremely repeatable connections.

The opens have a low-dielectric collet depressor that is flush with the outer conductor.

Both the opens and shorts are constructed so that the pin depth can be controlled very tightly, thereby minimizing phase errors. The lengths of the offsets in the opens and shorts are designed so that the difference in phase of their reflection coefficients is approximately 180 degrees at all frequencies.

Broadband Load

The broadband load is a metrology-grade termination that has been optimized for performance up to 18 GHz. The rugged internal structure provides for highly repeatable connections. A distributed resistive element on sapphire provides excellent stability and return loss. The broadband load is a valid substitute for a lowband load.

Calibration Definitions

The calibration kit must be selected and the calibration definitions for the devices in the kit installed in the network analyzer prior to performing a calibration. Refer to your network analyzer user's guide for instructions on selecting the calibration kit and performing a calibration.

The calibration definitions can be:

- resident within the analyzer
- loaded from the provided disk
- entered from the front panel

Installation of the Calibration Definitions

The calibration definitions for the kit may be permanently installed in the internal memory or hard disk of the network analyzer.

If the calibration definitions for the kit are not permanently installed in the network analyzer, they must be manually entered. Refer to your network analyzer user's guide for instructions.

Equipment Required but Not Supplied

Connector cleaning supplies and various electrostatic discharge (ESD) protection devices are not supplied with the calibration kit but are required to ensure successful operation of the kit. Refer to [Table 6-1 on page 6-2](#) for ordering information.

Incoming Inspection

Refer to [“Kit Contents” on page 1-2](#) to verify a complete shipment. Use [Table 1-1](#) to record the serial numbers of all serialized devices in your kit.

Check for damage. The foam-lined storage case provides protection during shipping. If the case or any device appears damaged, or if the shipment is incomplete, refer to [“Contacting Agilent” on page 5-4](#). Agilent will arrange for repair or replacement of incomplete or damaged shipments without waiting for a settlement from the transportation company. See [“Returning a Kit or Device to Agilent” on page 5-4](#).

Serial Numbers

A serial number is attached to this calibration kit. The first four digits followed by a letter comprise the serial number prefix; the last five digits are the suffix, unique to each calibration kit.

Recording the Device Serial Numbers

In addition to the kit serial number, the devices in the kit are individually serialized (serial numbers are labeled onto the body of each device). Record these serial numbers in [Table 1-1](#). Recording the serial numbers will prevent confusing the devices in this kit with similar devices from other kits.

Table 1-1 Serial Number Record for the 85050D

Device	Serial Number
Calibration kit	_____
Broadband load	_____
Open	_____
Short	_____

Calibration Kits Documented in This Manual

This manual applies to any 85050D calibration kit whose serial number is listed on the title page. If your calibration kit has a different serial number prefix, refer to the [“Calibration Kit History”](#) section below for information on how this manual applies.

Calibration Kit History

This section describes calibration kits with serial number prefixes lower than the ones listed on the title page.

85050D Kits with Serial Prefix 3027A

These calibration kits did not have the calibration definitions disk to support the Agilent 8510C network analyzer. The part numbers provided in this manual are the recommended replacement parts for these kits. The devices in these kits should meet the specifications published in this manual.

Preventive Maintenance

The best techniques for maintaining the integrity of the devices in the kit include:

- routine visual inspection
- cleaning
- proper gaging
- proper connection techniques

All of these are described in [Chapter 3](#) , “[Use, Maintenance, and Care of the Devices.](#)”

Failure to detect and remove dirt or metallic particles on a mating plane surface can degrade repeatability and accuracy and can damage any connector mated to it. Improper connections, resulting from pin depth values being out of the observed limits (see [Table 2-2 on page 2-5](#)) or from bad connection techniques, can also damage these devices.

2 Specifications

Environmental Requirements

Table 2-1 Environmental Requirements

Parameter	Limits
Temperature	
Operating ^a	+20 °C to +26 °C
Storage	-40 °C to +75 °C
Error-corrected range ^b	± 1 °C of measurement calibration temperature
Altitude	
Operating	< 4,500 meters (≈15,000 feet)
Storage	< 15,000 meters (≈50,000 feet)
Relative humidity	Always non-condensing
Operating	0 to 80% (26 °C maximum dry bulb)
Storage	0 to 90%

- a. The temperature range over which the calibration standards maintain conformance to their specifications.
- b. The allowable network analyzer ambient temperature drift during measurement calibration and during measurements when the network analyzer error correction is turned on. Also, the range over which the network analyzer maintains its specified performance while correction is turned on.

Temperature—What to Watch Out For

Changes in temperature can affect electrical characteristics. Therefore, the operating temperature is a critical factor in performance. During a measurement calibration, the temperature of the calibration devices must be stable and within the range shown in [Table 2-1](#).

IMPORTANT Avoid unnecessary handling of the devices during calibration because your fingers are a heat source.

Mechanical Characteristics

Mechanical characteristics such as center conductor protrusion and pin depth are *not* performance specifications. They are, however, important supplemental characteristics related to electrical performance. Agilent Technologies verifies the mechanical characteristics of the devices in the kit with special gaging processes and electrical testing. This ensures that the device connectors do not exhibit any center conductor protrusion or improper pin depth when the kit leaves the factory.

“Gaging Connectors” on page 3-6 explains how to use gages to determine if the kit devices have maintained their mechanical integrity. Refer to Table 2-2 on page 2-5 for typical and observed pin depth limits.

Pin Depth

Pin depth is the distance the center conductor mating plane differs from being flush with the outer conductor mating plane. See Figure 2-1. The pin depth of a connector can be in one of two states: either protruding or recessed.

Protrusion is the condition in which the center conductor extends beyond the outer conductor mating plane. This condition will indicate a positive value on the connector gage.

Recession is the condition in which the center conductor is set back from the outer conductor mating plane. This condition will indicate a negative value on the connector gage.

Figure 2-1 Connector Pin Depth

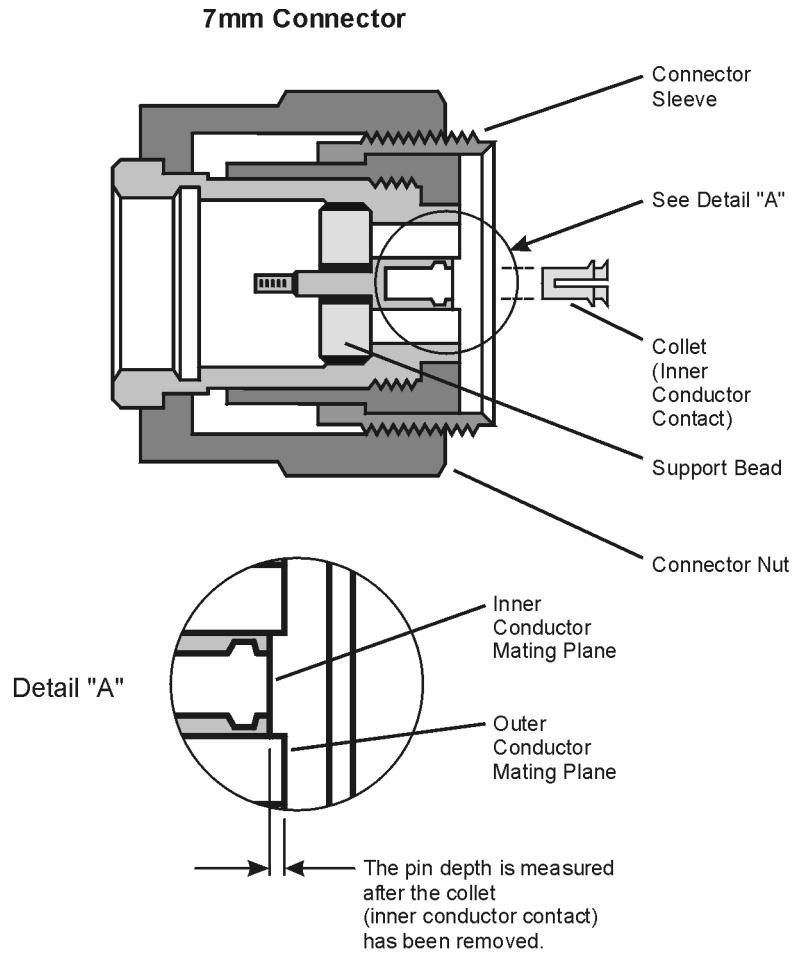

pi51b

The pin depth value of each calibration device in the kit is not specified, but is an important mechanical parameter. The electrical performance of the device depends, to some extent, on its pin depth. The electrical specifications for each device in the kit take into account the effect of pin depth on the device’s performance. [Table 2-2](#) lists the typical pin depths and measurement uncertainties, and provides observed pin depth limits for the devices in the kit. If the pin depth of a device does not measure within the *observed* pin depth limits, it may be an indication that the device fails to meet electrical specifications. Refer to [Figure 2-1](#) for a visual representation of proper pin depth (slightly recessed).

Table 2-2 Pin Depth Limits

Device	Typical Pin Depth micrometers (10 ⁻⁴ inches)	Measurement Uncertainty ^a micrometers (10 ⁻⁴ inches)	Observed Pin Depth Limits ^b micrometers (10 ⁻⁴ inches)
Opens	0 to -12.7 (0 to -5.0)	+10.02 to -10.2 (+ 4.0 to -4.0)	+10.2 to -22.91 (+ 4.0 to -9.0)
Shorts	0 to -5.1 (0 to -2.0)	+6.4 to -6.4 (+ 2.5 to -2.5)	+6.4 to -11.4 (+ 2.5 to -4.5)
Broadband loads	0 to -7.62 (0 to -3.0)	+4.1 to -4.1 (+ 1.6 to -1.6)	+4.1 to -11.7 (+ 1.6 to -4.6)

- a. Approximately +2 sigma to -2 sigma of gage uncertainty based on studies done at the factory according to recommended procedures.
- b. Observed pin depth limits are the range of observation limits seen on the gage reading due to measurement uncertainty. The depth could still be within specifications.

NOTE When measuring pin depth, the measured value (resultant average of three or more measurements) is *not* the true value. Always compare the measured value with the observed pin depth limits in [Table 2-2](#) to evaluate the condition of device connectors.

Electrical Specifications

The electrical specifications in [Table 2-3](#) apply to the devices in your calibration kit when connected with an Agilent precision interface.

Table 2-3 Electrical Specifications for 85050D 7 mm Devices

Device	Specification	Frequency (GHz)
Broadband loads	≥ 38 dB Return loss	dc to 18 GHz
Short ^a collet style	$\pm 0.2^\circ$ from nominal	dc to 2 GHz ^b
	$\pm 0.3^\circ$ from nominal	2 to 8 GHz ^b
	$\pm 0.5^\circ$ from nominal	8 to 18 GHz ^b
Open ^a with collet pusher	$\pm 0.3^\circ$ from nominal	dc to 2 GHz ^b
	$\pm 0.4^\circ$ from nominal	2 to 18 GHz ^b
	$\pm 0.6^\circ$ from nominal	8 to 18 GHz ^b

- a. The specifications for the opens and shorts are given as allowed deviation from the nominal model as defined in the standard definitions (see [“Nominal Standard Definitions” on page A-9](#)).
- b. Nominal, in this case, means the electrical characteristics as defined by the calibration constants supplied on the calibration constants disk.

Certification

Agilent Technologies certifies that this product met its published specifications at the time of shipment from the factory. Agilent further certifies that its calibration measurements are traceable to the United States National Institute of Standards and Technology (NIST) to the extent allowed by the institute’s calibration facility, and to the calibration facilities of other International Standards Organization members. See [“How Agilent Verifies the Devices in Your Kit” on page 4-2](#) for more information.

3 Use, Maintenance, and Care of the Devices

Electrostatic Discharge

Protection against electrostatic discharge (ESD) is essential while connecting, inspecting, or cleaning connectors attached to a static-sensitive circuit (such as those found in test sets).

Static electricity can build up on your body and can easily damage sensitive internal circuit elements when discharged. Static discharges too small to be felt can cause permanent damage. Devices such as calibration components and devices under test (DUT), can also carry an electrostatic charge. To prevent damage to the test set, components, and devices:

- *Always* wear a grounded wrist strap having a 1 M Ω resistor in series with it when handling components and devices or when making connections to the test set.
- *Always* use a grounded antistatic mat in front of your test equipment.
- *Always* wear a heel strap when working in an area with a conductive floor. If you are uncertain about the conductivity of your floor, wear a heel strap.
- *always* ground yourself before you clean, inspect, or make a connection to a static-sensitive device or test port. You can, for example, grasp the grounded outer shell of the test port or cable connector briefly.
- *always* ground the center conductor of a test cable before making a connection to the analyzer test port or other static-sensitive device. This can be done as follows:
 1. Connect a short (from your calibration kit) to one end of the cable to short the center conductor to the outer conductor.
 2. While wearing a grounded wrist strap, grasp the outer shell of the cable connector.
 3. Connect the other end of the cable to the test port.
 4. Remove the short from the cable.

Figure 3-1 shows a typical ESD protection setup using a grounded mat and wrist strap. Refer to Chapter 6 , “Replaceable Parts,” for information on ordering supplies for ESD protection.

Figure 3-1 ESD Protection Setup

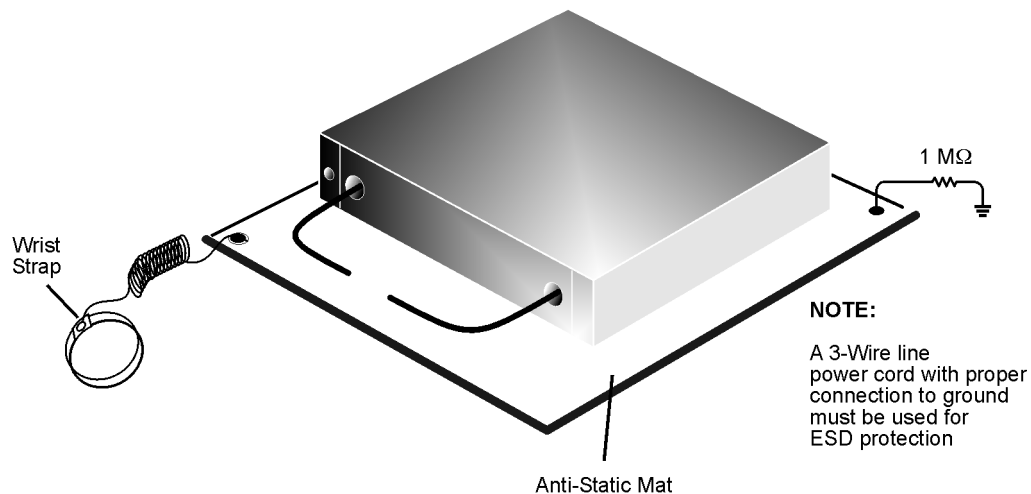

esd_setup

Visual Inspection

Visual inspection and, if necessary, cleaning should be done every time a connection is made. Metal particles from the connector threads may fall into the connector when it is disconnected. One connection made with a dirty or damaged connector can damage both connectors beyond repair.

In some cases, magnification is necessary to see damage to a connector; a magnifying device with a magnification of $\geq 10x$ is recommended. However, not all defects that are visible only under magnification will affect the electrical performance of the connector. Use the following guidelines when evaluating the integrity of a connector.

Look for Obvious Defects and Damage First

Examine the connectors first for obvious defects and damage: badly worn plating on the connector interface, deformed threads, or bent, broken, or misaligned center conductors. Connector nuts should move smoothly and be free of burrs, loose metal particles, and rough spots.

What Causes Connector Wear?

Connector wear is caused by connecting and disconnecting the devices. The more use a connector gets, the faster it wears and degrades. The wear is greatly accelerated when connectors are not kept clean, or are not connected properly.

Connector wear eventually degrades performance of the device. Calibration devices should have a long life if their use is on the order of a few times per week. Replace devices with worn connectors.

The test port connectors on the network analyzer test set may have many connections each day, and are, therefore, more subject to wear. It is recommended that an adapter be used as a test port saver to minimize the wear on the test set's test port connectors.

Inspect the Mating Plane Surfaces

Flat contact between the connectors at all points on their mating plane surfaces is required for a good connection. See [Figure 2-1 on page 2-4](#). Look especially for deep scratches or dents, and for dirt and metal particles on the connector mating plane surfaces. Also look for signs of damage due to excessive or uneven wear or misalignment.

Light burnishing of the mating plane surfaces is normal, and is evident as light scratches or shallow circular marks distributed more or less uniformly over the mating plane surface. Other small defects and cosmetic imperfections are also normal. None of these affect electrical or mechanical performance.

If a connector shows deep scratches or dents, particles clinging to the mating plane surfaces, or uneven wear, clean and inspect it again. Devices with damaged connectors should be discarded. Determine the cause of damage before connecting a new, undamaged connector in the same configuration.

Cleaning Connectors

Clean connectors are essential for ensuring the integrity of RF and microwave coaxial connections.

1. Use Compressed Air or Nitrogen

WARNING Always use protective eyewear when using compressed air or nitrogen.

Use compressed air (or nitrogen) to loosen particles on the connector mating plane surfaces. Clean air cannot damage a connector or leave particles or residues behind.

You can use any source of clean, dry, low-pressure compressed air or nitrogen that has an effective oil-vapor filter and liquid condensation trap placed just before the outlet hose.

Ground the hose nozzle to prevent electrostatic discharge, and set the air pressure to less than 414 kPa (60 psi) to control the velocity of the air stream. High-velocity streams of compressed air can cause electrostatic effects when directed into a connector. These electrostatic effects can damage the device. Refer to “[Electrostatic Discharge](#)” earlier in this chapter for additional information.

2. Clean the Connector Threads

WARNING Keep isopropyl alcohol away from heat, sparks, and flame. Store in a tightly closed container. It is extremely flammable. In case of fire, use alcohol foam, dry chemical, or carbon dioxide; water may be ineffective.

Use isopropyl alcohol with adequate ventilation and avoid contact with eyes, skin, and clothing. It causes skin irritation, may cause eye damage, and is harmful if swallowed or inhaled. It may be harmful if absorbed through the skin. Wash thoroughly after handling.

In case of spill, soak up with sand or earth. Flush spill area with water.

Dispose of isopropyl alcohol in accordance with all applicable federal, state, and local environmental regulations.

Use a lint-free swab or cleaning cloth moistened with isopropyl alcohol to remove any dirt or stubborn contaminants on a connector that cannot be removed with compressed air or nitrogen. Refer to [Table 6-1, “Replaceable Parts for the 85050D Calibration Kit,”](#) on page 6-2 for part numbers for isopropyl alcohol and cleaning swabs.

- a. Apply a small amount of isopropyl alcohol to a lint-free cleaning swab.
- b. Clean the connector threads.
- c. Let the alcohol evaporate, then blow the threads dry with a gentle stream of clean, low-pressure compressed air or nitrogen. Always completely dry a connector before you reassemble or use it.

3. Clean the Mating Plane Surfaces

- a. Apply a small amount of isopropyl alcohol to a lint-free cleaning swab.

- b. Clean the center and outer conductor mating plane surfaces. Refer to [Figure 2-1 on page 2-4](#). When cleaning a female connector, avoid snagging the swab on the center conductor contact fingers by using short strokes.
- c. Let the alcohol evaporate, then blow the connector dry with a gentle stream of clean, low-pressure compressed air or nitrogen. Always completely dry a connector before you reassemble or use it.

4. Inspect

Inspect the connector to make sure that no particles or residue remain. Refer to [“Visual Inspection” on page 3-3](#).

Gaging Connectors

The gages available from Agilent Technologies are intended for preventive maintenance and troubleshooting purposes only. See [Table 6-1 on page 6-2](#) for part number information. They are effective in detecting excessive center conductor protrusion or recession, and conductor damage on DUTs, test accessories, and the calibration kit devices. Do not use the gages for precise pin depth measurements.

Connector Gage Accuracy

The connector gages are only capable of performing coarse measurements. They do not provide the degree of accuracy necessary to precisely measure the pin depth of the kit devices. This is partially due to the repeatability uncertainties that are associated with the measurement. Only the factory—through special gaging processes and electrical testing— can accurately verify the mechanical characteristics of the devices.

With proper technique, the gages are useful in detecting gross pin depth errors on device connectors. To achieve maximum accuracy, random errors must be reduced by taking the average of at least three measurements having different gage orientations on the connector. Even the resultant average can be in error by as much as ± 0.0001 inch due to systematic (biasing) errors usually resulting from worn gages and gage masters. As the gages undergo more use, the systematic errors can become more significant in the accuracy of the measurement.

When to Gage Connectors

Gage a connector at the following times:

- Prior to using a device for the first time: record the pin depth measurement so that it can be compared with future readings. It will serve as a good troubleshooting tool when you suspect damage may have occurred to the device.

NOTE When measuring pin depth, the measured value (resultant average of three or more measurements) is not the true value. This is due to measurement uncertainties described earlier under [“Connector Gage Accuracy.”](#) Always compare the measured value with the pin depth specifications in [Table 2-2 on page 2-5](#) and with previously recorded values to evaluate the condition of device connectors.

- If either visual inspection or electrical performance suggests that the connector interface may be out of typical range (due to wear or damage, for example).
- If a calibration device is used by someone else or on another system or piece of equipment.
- Initially after every 100 connections, and after that as often as experience indicates.

Reading the Connector Gage

The gage dial is divided into increments of 0.0001 inch and major divisions of 0.001 inch (see [Figure 3-2](#)). For each revolution of the large dial, the smaller dial indicates a change of 0.01 inch. Use the small dial as the indicator of multiples of 0.01 inch. In most connector measuring applications, this value will be zero.

When making a measurement, the gage dial indicator will travel in one of two directions. If the center conductor is recessed from the *zero* reference plane, the indicator will move counterclockwise to indicate the amount of **recession**, which is read as a negative value. If the center conductor protrudes, the indicator will move clockwise to indicate the amount of **protrusion**, which is read as a positive value. Refer to [“Pin Depth” on page 2-3](#) for definitions of protrusion and recession.

Figure 3-2 Reading the Connector Gage

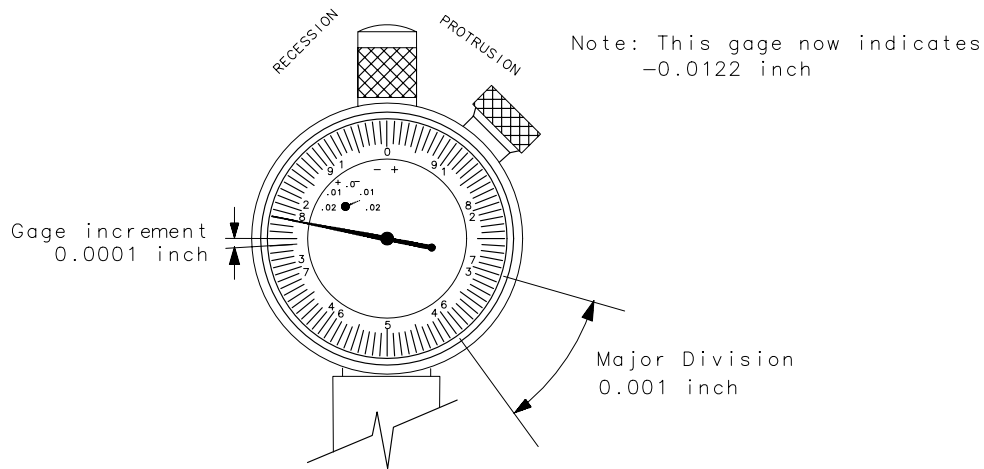

wj57f

Gaging Procedure

NOTE Always hold a connector gage by the gage barrel, below the dial indicator. This gives the best stability, and improves measurement accuracy.

1. Select the proper gage for your connector. Refer to [Table 6-1 on page 6-2](#) for the gage part number.
2. Inspect and clean the gage, gage master, and device to be gaged. Refer to [“Visual Inspection” on page 3-3](#) and [“Cleaning Connectors” on page 3-4](#) of this chapter.
3. Zero the connector gage (refer to [Figure 3-3](#)):
 - a. While holding the gage by the barrel, and without turning the gage or the device, connect the gage master to the gage. Refer to [“Connections” on page 3-10](#) for more information. Connect the nut finger tight. Do not overtighten.
 - b. Using an open-end wrench to keep the gage from rotating, use the torque wrench recommended for use with the kit to tighten the gage master connector nut to the specified torque. Refer to [“Final Connection Using a Torque Wrench” on page 3-10](#) for more information.
 - c. The gage pointer should line up exactly with the zero mark on the gage. If not, loosen the dial lock screw on the gage and rotate the gage dial so that the pointer is aligned with the zero mark.
 - d. Tighten the dial lock screw and remove the gage master.
 - e. Attach and torque the gage master to the gage once again to verify that the setting is repeatable. Remove the gage master.
4. Gage the device connector (refer to [Figure 3-3](#)):
 - a. While holding the gage by the barrel, and without turning the gage or the device, connect the gage master to the gage. Refer to [“Connections” on page 3-10](#) for more information. Connect the nut finger-tight. Do not overtighten.
 - b. Using an open-end wrench to keep the gage from rotating, use the torque wrench recommended for use with the kit to tighten the device connector nut to the specified torque. Refer to [“Final Connection Using a Torque Wrench” on page 3-10](#) for more information.
 - c. Gently tap the barrel of the gage with your finger to settle the gage reading.
 - d. Read the gage indicator dial. If the needle has moved clockwise, the center conductor is *protruding* by an amount indicated by the *black* numbers. If the needle has moved counterclockwise, the center conductor is *recessed* by an amount indicated by the *red* numbers.

For maximum accuracy, measure the connector a minimum of three times and take an average of the readings. After each measurement, rotate the gage a quarter-turn to reduce measurement variations that result from the gage or the connector face not being exactly perpendicular to the center axis.
 - e. Compare the average reading with the pin depth specifications listed in [Table 2-2 on page 2-5](#).
 - f. Remove the device from the gage.

Figure 3-3 Gaging 7 mm Connectors

Zero the Connector Gage

- Connect the gage master to the gage.
- Torque the connecting nut.
- Loosen the dial lock screw.
- Rotate the gage dial so that the pointer is aligned with the zero mark.
- Tighten the dial lock screw.
- Remove the gage master.

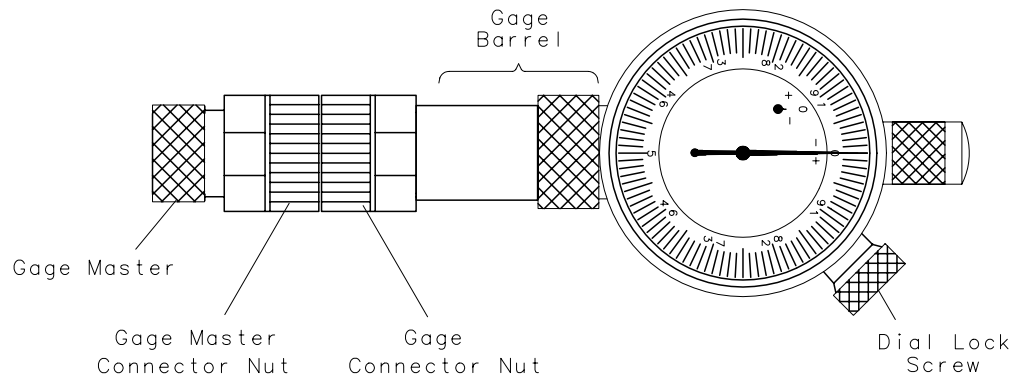

Gage the Device Connector

- Connect the device to the gage.
- Torque the connecting nut.
- Gently tap the gage barrel to settle the reading.
- Read recession or protrusion from the gage.
- Remove the device.
- Repeat two additional times and average the three readings.

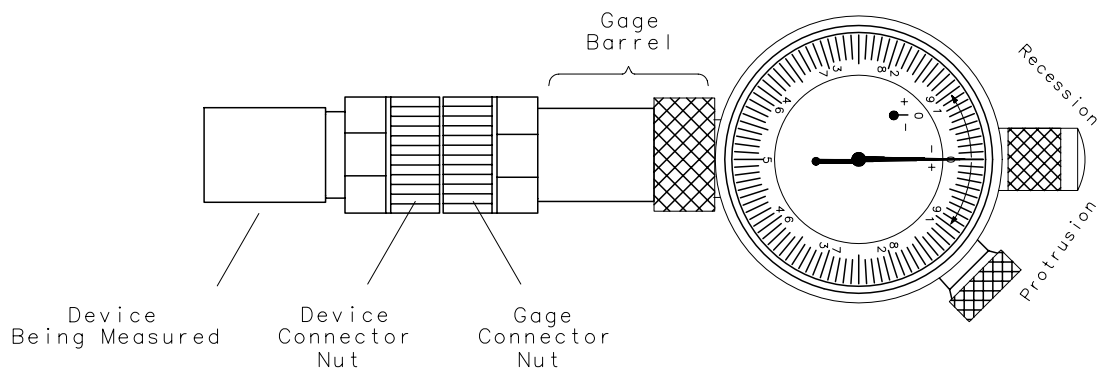

pi52b

Connections

Good connections require a skilled operator. *The most common cause of measurement error is bad connections.* The following procedures illustrate how to make good connections.

How to Make a Connection

Preliminary Connection

1. Ground yourself and all devices. Wear a grounded wrist strap and work on a grounded, conductive table mat. Refer to [“Electrostatic Discharge” on page 3-2](#) for ESD precautions.
2. Visually inspect the connectors. Refer to [“Visual Inspection” on page 3-3](#).
3. If necessary, clean the connectors. Refer to [“Cleaning Connectors” on page 3-4](#).
4. Use a connector gage to verify that all center conductors are within the pin depth specifications in [Table 2-2 on page 2-5](#). Refer to [“Gaging Connectors” on page 3-6](#).
5. Fully extend the connector sleeve on one of the connectors. Spin its knurled connector nut to make sure the threads are fully extended. Fully retract the sleeve on the other connector. The extended sleeve creates a cylinder into which the other connector fits.

If one of the connectors is fixed (such as on a test port), fully extend that connector sleeve and fully retract the sleeve on the moveable connector.

6. Carefully align the connectors. As you make the actual connection, be sure the connectors align perfectly.
7. Push the connectors straight together. Do *not* twist or screw the connectors together.
8. Engage the connector nut (of the connector with the retracted sleeve) over the threads of the other connector (the connector with the extended sleeve). Turn only the connector nut. Let the connector nut pull the two connectors straight together.
9. Do not overtighten this connection. A connection in which the outer conductors make gentle contact at all points on both mating surfaces is sufficient. Very light finger pressure is enough to accomplish this.
10. Make sure the connectors are properly supported. Relieve any side pressure on the connection from long or heavy devices or cables.

Final Connection Using a Torque Wrench

Use a torque wrench to make a final connection. [Table 3-1](#) provides information about the torque wrench recommended for use with the calibration kit. A torque wrench is included in the calibration kit. Refer to [Table 6-1 on page 6-2](#) for replacement part number and ordering information.

Table 3-1 Torque Wrench Information

Connector Type	Torque Setting	Torque Tolerance
7 mm	136 N-cm (12 in-lb)	± 13.6 N-cm (± 1.2 in-lb)

Using a torque wrench guarantees that the connection is not too tight, preventing possible connector damage. It also guarantees that all connections are equally tight each time.

Prevent the rotation of anything other than the connector nut that you are tightening. It may be possible to do this by hand if one of the connectors is fixed (as on a test port). However, it is recommended that you use an open-end wrench to keep the body of the device from turning.

1. Position both wrenches within 90 degrees of each other before applying force. See [Figure 3-4](#). Wrenches opposing each other (greater than 90 degrees apart) will cause a lifting action which can misalign and stress the connections of the devices involved. This is especially true when several devices are connected together.

Figure 3-4 Wrench Positions

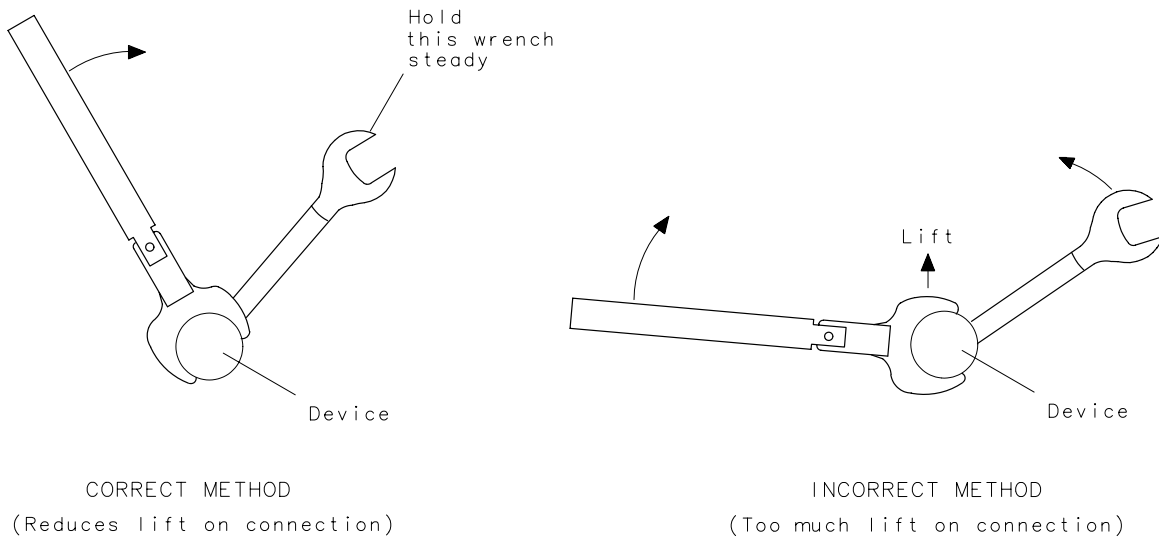

wj56f

2. Hold the torque wrench lightly, at the end of the handle only (beyond the groove). See [Figure 3-5](#).

Figure 3-5 Using the Torque Wrench

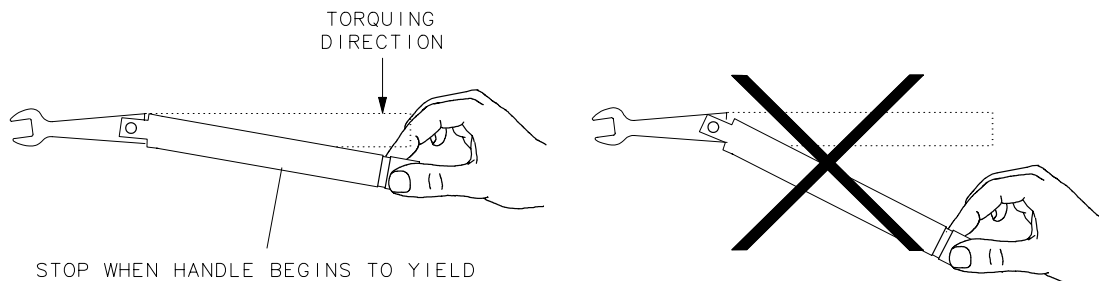

wj68d

Handling and Storage

3. Apply downward force perpendicular to the wrench handle. This applies torque to the connection through the wrench.

Do not hold the wrench so tightly that you push the handle straight down along its length rather than pivoting it, otherwise, you apply an unknown amount of torque.

4. Tighten the connection just to the torque wrench break point. The wrench handle gives way at its internal pivot point. See [Figure 3-5](#). Do not tighten the connection further.

CAUTION You don't have to fully break the handle of the torque wrench to reach the specified torque; doing so can cause the handle to kick back and loosen the connection. Any give at all in the handle is sufficient torque.

How to Separate a Connection

To avoid lateral (bending) force on the connector mating plane surfaces, always support the devices and connections.

CAUTION Do *not* turn the device body. Only turn the connector nut. Damage to the center conductor can occur if the device body is twisted.

1. Use an open-end wrench to prevent the device body from turning.
2. Use another open-end wrench to loosen the connecting nut.
3. Complete the separation by hand, turning only the connecting nut.
4. Pull the connectors straight apart without twisting, rocking, or bending either of the connectors.

CAUTION Do *not* twist one connector out of the other (like removing a light bulb). Turn the connector nut, not the device body. Major damage to the center conductor can occur if the device body is twisted.

Handling and Storage

- Install the protective end caps and store the calibration devices in the foam-lined storage case when not in use.
- Never store connectors loose in a box, or in a desk or bench drawer. This is the most common cause of connector damage during storage.
- Keep connectors clean.
- Do not touch mating plane surfaces. Natural skin oils and microscopic particles of dirt are easily transferred to a connector interface and are very difficult to remove.
- Do not set connectors contact-end down on a hard surface. The plating and the mating plane surfaces can be damaged if the interface comes in contact with any hard surface.

4 Performance Verification

Introduction

The performance of your calibration kit can only be verified by returning the kit to Agilent Technologies for recertification. The equipment required to verify the specifications of the devices in the kit has been specially manufactured and is not commercially available.

How Agilent Verifies the Devices in Your Kit

Agilent verifies the specifications of these devices as follows:

1. The residual microwave error terms of the test system are verified with precision airlines and shorts that are directly traced to the National Institute of Standards and Technology (NIST). The airline and short characteristics are developed from mechanical measurements. The mechanical measurements and material properties are carefully modeled to give very accurate electrical representation. The mechanical measurements are then traced to NIST through various plug and ring gages and other mechanical measurements.
2. Each calibration device is electrically tested on this system. For the initial (before sale) testing of the calibration devices, Agilent includes the test measurement uncertainty as a guardband to guarantee each device meets the published specification. For recertifications (after sale), no guardband is used and the measured data is compared directly with the specification to determine the pass or fail status. The measurement uncertainty for each device is, however, recorded in the calibration report that accompanies recertified kits.

These two steps establish a traceable link to NIST for Agilent to the extent allowed by the institute's calibration facility. The specifications data provided for the devices in the kit is traceable to NIST through Agilent Technologies.

Recertification

The following will be provided with a recertified kit:

- a new calibration sticker affixed to the case
- a certificate of calibration
- a calibration report for each device in the kit listing measured values, specifications, and uncertainties

NOTE A list of NIST traceable numbers may be purchased upon request to be included in the calibration report.

Agilent Technologies offers a *Standard* calibration for the recertification of the kit. For more information, contact Agilent Technologies. Refer to [“Contacting Agilent” on page 5-4](#) for a list of offices.

How Often to Recertify

The suggested initial interval for recertification is 12 months or sooner. The actual need for recertification depends on the use of the kit. After reviewing the results of the initial recertification, you may establish a different recertification interval that reflects the usage and wear of the kit.

NOTE The recertification interval should begin on the date the kit is *first used* after the recertification date.

Where to Send a Kit for Recertification

Contact Agilent Technologies for information on where to send your kit for recertification. Contact information is listed on [page 5-4](#). Refer to [“Returning a Kit or Device to Agilent” on page 5-4](#) for details on sending your kit.

5 Troubleshooting

Troubleshooting Process

If you suspect a bad calibration, or if your network analyzer does not pass performance verification, follow the steps in [Figure 5-1](#).

Figure 5-1 Troubleshooting Flowchart

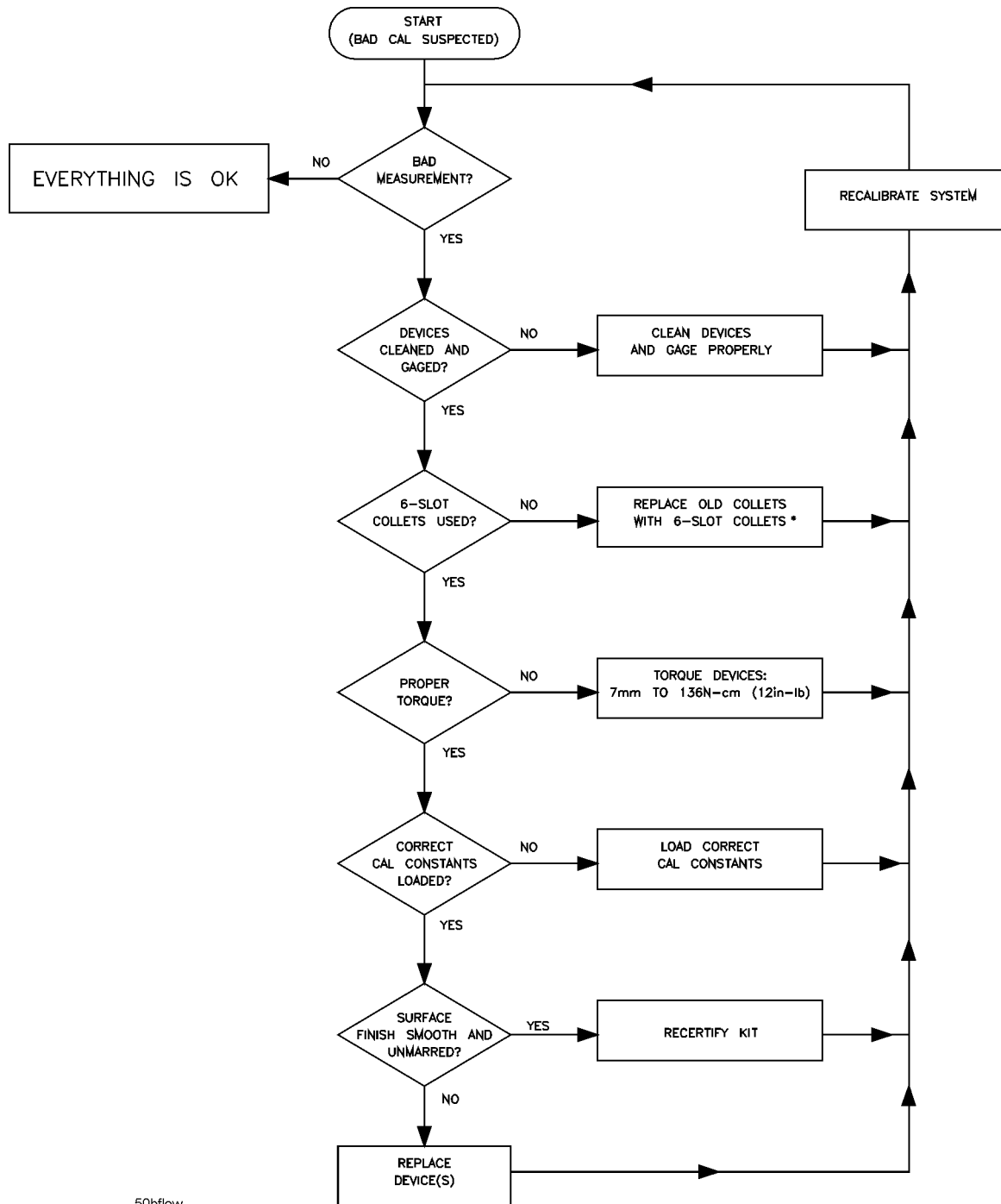

50bflow

Returning a Kit or Device to Agilent

If your kit or device requires service, contact Agilent Technologies for information on where to send it. See [Table 5-1](#) for contact information. Include a service tag (located near the end of this manual) on which you provide the following information:

- your company name and address
- a technical contact person within your company, and the person's complete telephone number
- the model number and serial number of the kit
- the part number and serial number of each device
- the type of service required
- a *detailed* description of the problem and how the device was being used when the problem occurred (such as calibration or measurement)

Where to Look for More Information

This manual contains limited information about network analyzer system operation. For complete information, refer to the instrument documentation. If you need additional information, contact Agilent Technologies.

Contacting Agilent

Table 5-1 Contacting Agilent

Online assistance: www.agilent.com/find/assist

United States <i>(tel)</i> 1 800 452 4844	Latin America <i>(tel)</i> (305) 269 7500 <i>(fax)</i> (305) 269 7599	Canada <i>(tel)</i> 1 877 894 4414 <i>(fax)</i> (905) 282-6495	Europe <i>(tel)</i> (+31) 20 547 2323 <i>(fax)</i> (+31) 20 547 2390
New Zealand <i>(tel)</i> 0 800 738 378 <i>(fax)</i> (+64) 4 495 8950	Japan <i>(tel)</i> (+81) 426 56 7832 <i>(fax)</i> (+81) 426 56 7840	Australia <i>(tel)</i> 1 800 629 485 <i>(fax)</i> (+61) 3 9210 5947	Singapore <i>(tel)</i> 1 800 375 8100 <i>(fax)</i> (65) 836 0252
Malaysia <i>(tel)</i> 1 800 828 848 <i>(fax)</i> 1 800 801 664	Philippines <i>(tel)</i> (632) 8426802 <i>(tel) (PLDT subscriber only):</i> 1 800 16510170 <i>(fax)</i> (632) 8426809 <i>(fax) (PLDT subscriber only):</i> 1 800 16510288	Thailand <i>(tel) outside Bangkok:</i> (088) 226 008 <i>(tel) within Bangkok:</i> (662) 661 3999 <i>(fax)</i> (66) 1 661 3714	Hong Kong <i>(tel)</i> 800 930 871 <i>(fax)</i> (852) 2506 9233
Taiwan <i>(tel)</i> 0800-047-866 <i>(fax)</i> (886) 2 25456723	People's Republic of China <i>(tel) (preferred):</i> 800-810-0189 <i>(tel) (alternate):</i> 10800-650-0021 <i>(fax)</i> 10800-650-0121	India <i>(tel)</i> 1-600-11-2929 <i>(fax)</i> 000-800-650-1101	

6 Replaceable Parts

Introduction

Table 6-1 lists the replacement part numbers for:

- the 85050D calibration kit
- items not included in the calibration kit that are either required or recommended for successful operation of the kit

To order a listed part, note the description, the part number, and the quantity desired. Telephone or send your order to Agilent Technologies. See Table 5-1 on page 5-4 for contact information.

Table 6-1 Replaceable Parts for the 85050D Calibration Kit

Description	Qty Per Kit	Agilent Part Number
Calibration Devices (7 mm)		
7 mm broadband load	1	85050-60006
7 mm short	1	85050-80007
7 mm open	1	85052-80010
Miscellaneous Items		
3/4 in, 135 N-cm (12 in-lb) torque wrench	1	8710-1766
Calibration kit storage case with foam	1	85050-60011
User's and service guide	1	85050-90052
Calibration definitions disk (PNA)	1	85050-10010
Calibration definitions disk (8510, 872x Series)	1	85050-10007
Specifications and performance verification disk ^a	1	08510-10033
Connector care—quick reference card	1	08510-90360
Items Not Included in Kit		
7 mm connector gage set ^b	1	85050-80012
Isopropyl alcohol	30 ml	8500-5344
Foam-tipped cleaning swabs	100	9301-1243
Grounding wrist strap	1	9300-1367
5 ft grounding cord for wrist strap	1	9300-0980
2 ft by 4 ft conductive table mat with 15 ft grounding wire	1	9300-0797
ESD heel strap (for conductive floors)	1	9300-1308

a. See the 8510C *On-Site Service Manual* for instructions on using the disk.

b. Gage set includes gage, gage master, aligning pin, and two centering beads.

Figure 6-1 Replaceable Parts for the 85052D Calibration Kit

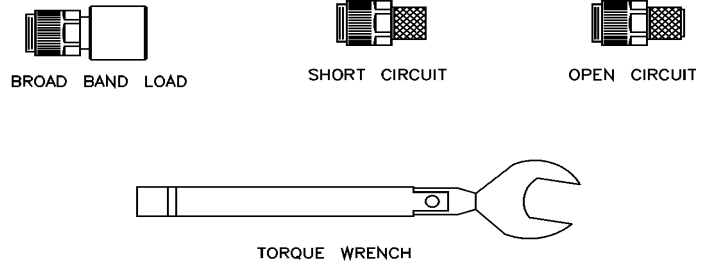

50dpts1

A Standard Definitions

Version Changes

Class assignments and standard definitions may change as more accurate model and calibration methods are developed. The disk shipped with the kit will contain the most recent version.

Standard Class Assignments

Class assignment organizes calibration standards into a format compatible with the error models used in the measurement calibration. A class or group of classes corresponds to the systematic errors to be removed from the measured network analyzer response. Tables A-1 through A-3 list the classes of the devices in the kit for various network analyzers. This information resides on the calibration definitions disk included in the kit.

Table A-1 Standard Class Assignments for the 8510 Network Analyzer

Disk File Name: CK_7MMD2				Calibration Kit Label: 7 mm D.2				Standard Class Label
				File Number: * FILE 1				
Class	A	B	C	D	E	F	G	Standard Class Label
S ₁₁ A	2							Open
S ₁₁ B	1							Short
S ₁₁ C	9							Loads
S ₂₂ A	2							Open
S ₂₂ B	1							Short
S ₂₂ C	9							Loads
Forward transmission	11							Thru
Reverse transmission	11							Thru
Forward match	11							Thru
Reverse match	11							Thru
Forward isolation ^a	9							Isol'n Std
Reverse isolation	9							Isol'n Std
Frequency response	1	2	11					Response
TRL thru								Undefined
TRL reflect								Undefined
TRL line								Undefined
Adapter	13							Adapter
TRL Option								
Cal Z ₀ : ___ System Z ₀ <u> X </u> Line Z ₀								
Set ref: <u> X </u> Thru ___ Reflect								
Lowband frequency: ___								

a. The forward isolation standard is also used for the isolation part of the response and isolation calibration.

Table A-2 Standard Class Assignments for the 872x Series Network Analyzer

Calibration Kit Label: [7 mm]								
Class	A	B	C	D	E	F	G	Standard Class Label
S ₁₁ A	2							Open
S ₁₁ B	1							Short
S ₁₁ C	3							Loads
S ₂₂ A	2							Open
S ₂₂ B	1							Short
S ₂₂ C	3							Loads
Forward transmission	4							Thru
Reverse transmission	4							Thru
Forward match	4							Thru
Reverse match	4							Thru
Response	1	2	4					Response
Response & isolation	1	2	4					Response
TRL thru	4							Thru
TRL reflect	2							Open
TRL line or match	3	5	6					Loads
TRL Option								
Cal Z ₀ :	_____ System Z ₀		___X___ Line Z ₀					
Set ref:	___X___ Thru		_____ Reflect					

Table A-3 Standard Class Assignments for the PNA Series Network Analyzer

Calibration Kit Label: 7 mm Model 85050D	
Class	A ^a
S ₁₁ A	2
S ₁₁ B	1
S ₁₁ C	3
S ₂₁ T	4
S ₂₂ A	2
S ₂₂ B	1
S ₂₂ C	3
S ₁₂ T	4

- a. For additional ports, make sure values match the correct sex of the port.

IMPORTANT The following calibrations are only supported by certain PNA analyzers. See your PNA series network analyzer embedded help system.

Notes:

1. If you are performing a TRL calibration:

- S₂₁T and S₁₂T must be defined as *thru* standards.
- S₁₁A and S₂₂A must be defined as *reflection* standards.
- S₁₁B, S₁₁C, S₂₂B, and S₂₂C must be defined as *line* standards.

2. If you are performing a TRM calibration:

- S₂₁T and S₁₂T must be defined as *thru* standards.
- S₁₁A and S₂₂A must be defined as *reflection* standards.
- S₁₁B, S₁₁C, S₂₂B, and S₂₂C must be defined as *match* standards.

3. If you are performing an LRM calibration:

- S₂₁T and S₁₂T must be defined as *line* standards.
- S₁₁A and S₂₂A must be defined as *reflection* standards.
- S₁₁B, S₁₁C, S₂₂B, and S₂₂C must be defined as *match* standards.

4. S₁₁B and S₁₁C must be defined as the same standard.

5. **S₂₂B and S₂₂C must be defined as the same standard.**

For additional information on performing TRL, TRM, and LRM calibrations, refer to your PNA series network analyzer embedded help system.

Blank Forms

The standard class assignments may be changed to meet your specific requirements. Tables A-4 through A-6 are provided to record the modified standard class assignments.

Table A-4 Blank Form for the 8510 Network Analyzer

Disk File Name: _____				Calibration Kit Label: _____				
				File Number: _____				
Class	A	B	C	D	E	F	G	Standard Class Label
S ₁₁ A								
S ₁₁ B								
S ₁₁ C								
S ₂₂ A								
S ₂₂ B								
S ₂₂ C								
Forward transmission								
Reverse transmission								
Forward match								
Reverse match								
Forward isolation ^a								
Reverse isolation								
Frequency response								
TRL thru								
TRL reflect								
TRL line								
Adapter								
TRL Option								
Cal Z ₀ : _____ System Z ₀			_____ Line Z ₀					
Set ref: _____ Thru			_____ Reflect					
Lowband frequency ^b : _____								

a. The forward isolation standard is also used for the isolation part of the response and isolation calibration.
 b. Broadband loads are used for frequencies up to 2 GHz.

Table A-5 Blank Form for the 872x Series of Network Analyzers

Calibration Kit Label: _____								
Class	A	B	C	D	E	F	G	Standard Class Label
S ₁₁ A								
S ₁₁ B								
S ₁₁ C								
S ₂₂ A								
S ₂₂ B								
S ₂₂ C								
Forward transmission								
Reverse transmission								
Forward match								
Reverse match								
Response								
Response & isolation								
TRL thru								
TRL reflect								
TRL line or match								
TRL Option								
Cal Z ₀ :	_____ System Z ₀	_____ Line Z ₀						
Set ref:	_____ Thru	_____ Reflect						

Table A-6 Blank Form for the PNA Series Network Analyzers

Calibration Kit Label:	
Class	A^a
S ₁₁ A	
S ₁₁ B	
S ₁₁ C	
S ₂₁ T	
S ₂₂ A	
S ₂₂ B	
S ₂₂ C	
S ₁₂ T	

a. For additional ports, make sure values match the correct sex of the port.

IMPORTANT The following calibrations are only supported by certain PNA analyzers. See your PNA series network analyzer embedded help system.

Notes:

1. If you are performing a TRL calibration:

- S₂₁T and S₁₂T must be defined as *thru* standards.
- S₁₁A and S₂₂A must be defined as *reflection* standards.
- S₁₁B, S₁₁C, S₂₂B, and S₂₂C must be defined as *line* standards.

2. If you are performing a TRM calibration:

- S₂₁T and S₁₂T must be defined as *thru* standards.
- S₁₁A and S₂₂A must be defined as *reflection* standards.
- S₁₁B, S₁₁C, S₂₂B, and S₂₂C must be defined as *match* standards.

3. If you are performing an LRM calibration:

- S₂₁T and S₁₂T must be defined as *line* standards.
- S₁₁A and S₂₂A must be defined as *reflection* standards.
- S₁₁B, S₁₁C, S₂₂B, and S₂₂C must be defined as *match* standards.

4. S₁₁B and S₁₁C must be defined as the same standard.

5. **S₂₂B and S₂₂C must be defined as the same standard.**

For additional information on performing TRL, TRM, and LRM calibrations, refer to your PNA series network analyzer embedded help system.

Nominal Standard Definitions

Standard definitions provide the constants needed to mathematically model the electrical characteristics (delay, attenuation, and impedance) of each calibration standard. The nominal values of these constants are theoretically derived from the physical dimensions and material of each calibration standard, or from actual measured response. These values are used to determine the measurement uncertainties of the network analyzer. The standard definitions in [Tables A-7 through A-9](#) list typical calibration kit parameters used to specify the mathematical model of each device. This information must be loaded into the network analyzer to perform valid calibrations. Refer to your network analyzer user's guide for instructions on loading calibration definitions.

NOTE The values in the standard definitions table are valid *only* over the specified operating temperature range.

Setting the System Impedance

This kit contains only 50 ohm devices. Ensure the system impedance (Z_0) is set to 50 ohms. Refer to your network analyzer's user's guide for instructions on setting system impedance.

Table A-7 Standard Definitions for the 8510 Network Analyzer

System $Z_0^a = 50.0 \Omega$ Disk File Name: CK_7MMB2						Calibration Kit Label: 7 mm B.2 File Number: * FILE 1							
Number	Standard ^b Type	$C0 \times 10^{-15} \text{ F}$	$C1 \times 10^{-27} \text{ F/Hz}$	$C2 \times 10^{-36} \text{ F/Hz}^2$	$C3 \times 10^{-45} \text{ F/Hz}^3$	Fixed or Sliding ^c	Offset			Frequency in GHz ^d		Coax or Waveguide	Standard Label
		$L0 \times 10^{-12} \text{ H}$	$L1 \times 10^{-24} \text{ H/Hz}$	$L2 \times 10^{-33} \text{ H/Hz}^2$	$L3 \times 10^{-42} \text{ H/Hz}^3$		Delay	$Z_0 \Omega$	Loss in G Ω /s	Min	Max		
1	Short ^e	0.3566	-33.392	1.7542	-0.0336		0	50	0	0	999	Coax	Short
2	Open ^e	90.48	763.6	-63.818	6.4337		0	50	0	0	999	Coax	Open
3													
4													
5													
6													
7													
8													
9	Load					Fixed	0	50	0	0	999	Coax	Broadband
10													
11	Delay/ thru						0	50	0	0	999	Coax	Thru
12	Load					Fixed	0	50	0	0	3.001	Coax	Lowband
13	Delay/ thru						0	50	0	0	999	Coax	Undefined
14													
15													
16													
17													
18													
19													
20													
21													

- a. Ensure system Z_0 of network analyzer is set to this value.
- b. Open, short, load, delay/thru, or arbitrary impedance.
- c. Load or arbitrary impedance only.
- d. For waveguide, the lower frequency is the same as F_{CO} .
- e. Typical values only. Disk values may be different.

Table A-8 Standard Definitions for the 872x Series Network Analyzer

Standard ^b						Fixed or Sliding ^c	Offset			Frequency in GHz ^d		Coax or Waveguide	Standard Label
		C0 ×10 ⁻¹⁵ F	C1 ×10 ⁻²⁷ F/Hz	C2 ×10 ⁻³⁶ F/Hz ²	C3 ×10 ⁻⁴⁵ F/Hz ³		Delay in ps	Z ₀ Ω	Loss in GΩ/s	Min	Max		
1	Short	0	0	0	0		0	50	0.7	0	999	Coax	Short
2	Open	87.2	1695.0	-150.5	8.89		0	50	0.7	0	999	Coax	Open
3	Load					Fixed	0	50	0.7	0	999	Coax	Broadband
4	Delay/ thru						0	50	0.7	0	999	Coax	Thru
5													
6													
7													
8													

- a. Ensure system Z₀ of network analyzer is set to this value.
- b. Open, short, load, delay/thru, or arbitrary impedance.
- c. Load or arbitrary impedance only.
- d. For waveguide, the lower frequency is the same as F_{CO}.

Table A-9 Standard Definitions for the PNA Series Network Analyzer

System $Z_0^a = 50.0 \Omega$						Calibration Kit Label: 7 mm Model 85050D							
Standard ^b		$C0 \times 10^{-18} \text{ F}$	$C1 \times 10^{-30} \text{ F/Hz}$	$C2 \times 10^{-39} \text{ F/Hz}^2$	$C3 \times 10^{-48} \text{ F/Hz}^3$	Fixed or sliding	Offset			Frequency in GHz ^c		Coax or Waveguide	Standard Label
Number	Type	$L0 \times 10^{-12} \text{ H}$	$L1 \times 10^{-24} \text{ H/Hz}$	$L2 \times 10^{-33} \text{ H/Hz}^2$	$L3 \times 10^{-45} \text{ H/Hz}^3$		Delay in ps	$Z_0 \Omega$	Loss in GΩ/s	Min	Max		
1	Short	0.3566	-33.392	1.7542	-0.0336		0	50	0	0	999	Coax	Short
2	Open	90.48	763.6	-63.818	6.4337		0	50	0	0	999	Coax	Open
3	Broadband load					Fixed	0	50	0	0	999	Coax	Broadband load
4	Thru						0	50	0	0	999	Coax	Thru
5													
6													
7													
8													

- a. Ensure system Z_0 of network analyzer is set to this value.
- b. Open, short, load, delay/thru, or arbitrary impedance.
- c. For waveguide, the lower frequency is the same as F_{CO} .

Blank Forms

The standard definitions may be changed to meet your specific requirements. Tables A-10 through A-12 are provided to record the modified standard definitions.

Table A-10 Blank Form for the 8510 Network Analyzer

System Z_0 ^a = _____						Calibration Kit Label: _____								
Disk File Name: _____						File Number: _____								
Number	Standard ^b Type	$C_0 \times 10^{-15}$ F	$C_1 \times 10^{-27}$ F/Hz	$C_2 \times 10^{-36}$ F/Hz ²	$C_3 \times 10^{-45}$ F/Hz ³	Fixed or sliding ^c	Offset			Frequency in GHz ^d		Coax or Waveguide	Standard Label	
		$L_0 \times 10^{-12}$ H	$L_1 \times 10^{-24}$ H/Hz	$L_2 \times 10^{-33}$ H/Hz ²	$L_3 \times 10^{-42}$ H/Hz ³		Delay	$Z_0 \Omega$	Loss in GΩ/s	Min	Max			
1														
2														
3														
4														
5														
6														
7														
8														
9														
10														
11														
12														
13														
14														
15														
16														
17														
18														
19														
20														
21														

- a. Ensure system Z_0 of network analyzer is set to this value.
- b. Open, short, load, delay/thru, or arbitrary impedance.
- c. Load or arbitrary impedance only.
- d. For waveguide, the lower frequency is the same as F_{CO} .

Table A-11 Blank Form for the 872x Series of Network Analyzers

System $Z_0^a = 50.0 \Omega$		Calibration Kit Label: []											
Standard ^b		$C0 \times 10^{-15} \text{ F}$	$C1 \times 10^{-27} \text{ F/Hz}$	$C2 \times 10^{-36} \text{ F/Hz}^2$	$C3 \times 10^{-45} \text{ F/Hz}^3$	Fixed or Sliding ^c	Offset			Frequency in GHz ^d		Coax or Waveguide	Standard Label
Number	Type						Delay in ps	$Z_0 \Omega$	Loss in GΩ/s	Min	Max		
1													
2													
3													
4													
5													
6													
7													
8													

- a. Ensure system Z_0 of network analyzer is set to this value.
- b. Open, short, load, delay/thru, or arbitrary impedance.
- c. Load or arbitrary impedance only.
- d. For waveguide, the lower frequency is the same as F_{C0} .

Table A-12 Blank Form for the PNA Series of Network Analyzers

System $Z_0^a =$ _____		Calibration Kit Label: _____													
Number	Type	Standard ^b				Fixed or sliding	Offset			Frequency in GHz ^c		Coax or Waveguide	Standard Label		
		$C0 \times 10^{-18}$ F	$C1 \times 10^{-30}$ F/Hz	$C2 \times 10^{-39}$ F/Hz ²	$C3 \times 10^{-48}$ F/Hz ³		$L0 \times 10^{-12}$ H	$L1 \times 10^{-24}$ H/Hz	$L2 \times 10^{-33}$ H/Hz ²	$L3 \times 10^{-45}$ H/Hz ³	Delay in ps			$Z_0 \Omega$	Loss in GΩ/s
1															
2															
3															
4															
5															
6															
7															
8															

- a. Ensure system Z_0 of network analyzer is set to this value.
- b. Open, short, load, delay/thru, or arbitrary impedance.
- c. For waveguide, the lower frequency is the same as F_{CO} .

A

- adapters
 - specifications, 2-6
- Agilent Technologies
 - contacting, 5-4
- agreements
 - customer assistance, ii
 - maintenance, ii
- alcohol
 - isopropyl
 - as cleaning solvent, 3-4
 - precautions for use of, 3-4
- altitude, specifications, 2-2
- assistance
 - contacting agilent, 5-4
 - customer, ii
 - who to contact, ii

B

- blank forms
 - standard class assignments, A-6
 - standard definitions, A-13
- broadband loads, 1-2
 - part numbers, 6-2
 - specifications, 2-6

C

- cal kit
 - contents, 1-2
 - history, 1-4
 - verifying, 4-2
- calibration
 - bad, 5-2
 - certificate of, 4-3
 - constants, 1-3
 - permanently stored, 1-3
 - report, 4-3
 - temperature, 2-2
- calibration constants
 - disk, part number, 6-2
 - entering, 1-3
 - permanently stored, 1-3
- calibration definitions, 1-3
- calibration kit
 - contents, 1-2
 - drawing of, 6-3
 - history, 1-4
 - overview, 1-2
 - performance
 - how Agilent verifies, 4-2
- center conductor
 - protrusion, 3-7
 - recession, 3-7
- certificate of calibration, 4-3
- certification
 - of device specifications, 2-6
- characteristics
 - mechanical, 2-3
- class assignments

- blank forms, A-6
 - standard, A-3
- cleaning connectors, 3-4
- cleaning supplies, 1-3
- compressed air
 - for cleaning, 3-4
- connections, 3-2, 3-10
 - ESD protection, 3-2, 3-10
 - final, 3-10
 - preliminary, 3-10
 - separating, 3-12
 - using torque wrench, 3-10
- connector
 - cleaning, 3-4
 - damage, 3-3
 - defects, 3-3
 - gage
 - accuracy, 3-6
 - dial, 3-7
 - handling, 3-8
 - reading, 3-7
 - use of, 3-6
 - zeroing, 3-8
 - gaging, 3-6
 - when to do, 3-6
 - male, 3-8
 - mating plane surfaces
 - cleaning, 3-4
 - threads
 - cleaning, 3-4
 - inspecting, 3-3
 - visual inspection, 3-3
 - wear, 3-3
 - affect on electrical performance, 3-3
- constants
 - calibration, 1-3
 - entering, 1-3
 - permanently stored, 1-3
 - part numbers, 6-2
- contacting Agilent Technologies, 5-4
- contents
 - calibration kit, 1-2
 - drawing of, 6-3
 - incomplete
 - what to do, 1-3

D

- damage
 - caused by electrostatic discharge, 3-2
 - device, 3-3
 - inspecting for, 3-3
 - to connectors, 3-3
- data
 - recertification, 4-3
- defective connectors, 3-3
- definitions
 - standard, A-9
- deviation from nominal phase, 2-6
- device
 - cleaning, 3-4

Index

- connecting, 3-10
- damage, 3-3
- disconnecting, 3-12
- handling, 3-12
- maintenance, 1-5
- performance
 - verifying, 4-2
- specifications, 2-6
 - certification of, 2-6
 - electrical, 2-6
 - traceability, 4-2, 4-3
- storage, 3-12
- temperature, 2-2
- visual inspection, 3-3
- dial
 - connector gage, 3-7
- disconnections, 3-12
- disk
 - calibration definitions
 - part number, 6-2
 - specifications and performance
 - part number, 6-2
- documentation warranty, ii
- documentation, part number, 6-2

E

- electrical characteristics
 - effects of temperature, 2-2
- electrical specifications, 2-6
- electrostatic discharge, *See* ESD
- environmental
 - regulations, 3-4
 - requirements, 2-2
 - specifications, 2-2
- equipment required, 1-3
- ESD, 3-2
 - protection, 3-2

F

- flowchart, troubleshooting, 5-2
- frequency specifications, 2-6

G

- gage
 - connector, 1-3
 - dial, 3-7
 - handling, 3-8
 - reading, 3-7
 - zeroing, 3-8
- gaging
 - connectors, 3-6
 - when to do, 3-6
 - male connectors, 3-8
 - to determine pin depth, 3-6
- general information, 1-1

H

- handling, 3-12
- humidity specifications, 2-2

I

- impedance
 - system, A-9
 - setting, A-9
- incoming inspection, 1-3
- information, troubleshooting, 5-4
- inspection
 - damage, 3-3
 - defects, 3-3
 - incoming, 1-3
 - mating plane surfaces, 3-3
 - visual, 3-3
- isopropyl alcohol
 - as cleaning solvent, 3-4
 - precautions for use of, 3-4

K

- kit
 - contents, 1-2, 6-3
 - drawing of, 6-3
 - overview, 1-2

L

- limits
 - pin depth, 2-5
- loads
 - broadband, 1-2
 - part numbers, 6-2

M

- maintenance, 3-2
 - agreements, ii
 - of devices, 1-5
 - preventive, 1-5
- making connections, 3-10
 - ESD protection, 3-2, 3-10
 - precautions, 3-10
- manual
 - part number, 6-2
- mating plane surfaces
 - cleaning, 3-4
 - connector, 3-4
 - inspection of, 3-3
- mechanical characteristics, 2-3
 - affect on electrical performance, 2-3
 - verifying, 3-6

N

- National Institute of Standards and Technology (NIST), 2-6, 4-2
- nitrogen, for cleaning, 3-4
- nominal standard definitions, A-9
- numbers
 - replaceable parts, 6-2
 - serial, 1-4

O

- observed limits

- pin depth, 2-5
- offset opens and shorts, 1-2
 - part numbers, 6-2
 - specifications, 2-6
- open-end wrench, 1-2, 3-12
- opens, 1-2
 - part numbers, 6-2
 - specifications, 2-6
- ordering parts, 6-2

P

- part numbers, 6-2
 - of items in kit, 6-2
 - of items not in kit, 6-2
- parts
 - included in kit, 1-2, 6-2
 - not included in kit, 6-2
 - ordering, 6-2
 - replaceable, 6-2
- performance
 - and specifications disk
 - part number, 6-2
- performance verification
 - failure, 5-2
- permanently stored calibration definitions, 1-3
- pin depth, 2-3
 - affect on electrical performance, 2-5
 - gaging to determine, 3-6
 - observed limits, 2-5, 3-6
 - protrusion, 2-3
 - recession, 2-3
 - typical values, 2-5
- preventive maintenance, 1-5
- procedures
 - cleaning, 3-4
- protrusion
 - center conductor, 3-7
 - pin depth, 2-3

R

- reading connector gage, 3-7
- recertification
 - how to order, 4-3
 - interval, 4-3
 - locations, 4-3
 - services included, 4-3
- recession
 - center conductor, 3-7
 - pin depth, 2-3
- regulations
 - environmental, 2-2, 3-4
- replaceable parts, 6-2
 - drawing of, 6-3
- report, calibration, 4-3
- requirements
 - environmental, 2-2
- return kit or device to Agilent, 1-3, 5-4
- return loss, specifications, 2-6

S

- separating connections, 3-12
- serial numbers, 1-4
 - devices, 1-4
 - recording, 1-4
- service, 5-4
- service tag, 4-3, 5-4
- shorts, 1-2
 - part numbers, 6-2
 - specifications, 2-6
- specifications, 2-2
 - adapters, 2-6
 - altitude
 - operating, 2-2
 - storage, 2-2
 - and performance disk
 - part number, 6-2
 - broadband loads, 2-6
 - certification of, 2-6
 - deviation from nominal phase, 2-6
 - device, 2-6
 - electrical, 2-6
 - environmental, 2-2
 - frequency, 2-6
 - humidity
 - operating, 2-2
 - storage, 2-2
 - offset opens and shorts, 2-6
 - return loss, 2-6
 - sliding loads, 2-6
 - temperature, 2-2
 - torque wrench, 3-10
 - traceability, 4-2, 4-3
- standard class assignments, A-3
 - blank forms, A-6
- standard definitions, A-9, A-13
 - blank forms, A-13
 - nominal, A-9
- standards
 - international, 2-6
 - National Institute of Standards and Technology (NIST), 2-6, 4-2
- static
 - discharge, 3-2
 - electricity, 3-2
- storage, 3-12
- supplies
 - cleaning, 1-3
- swabs
 - cleaning, 3-4
- system impedance, A-9

T

- tag
 - service, 4-3, 5-4
- temperature
 - affect on electrical performance, 2-2
 - calibration, 2-2
 - cautions about, 2-2

Index

- changes in, [2-2](#)
- device, [2-2](#)
- error-corrected, [2-2](#)
- measurement, [2-2](#)
- specifications, [2-2](#)
 - operating, [2-2](#)
 - storage, [2-2](#)
- verification and measurement, [2-2](#)
- test data, [4-3](#)
- threads
 - connector
 - cleaning, [3-4](#)
 - inspecting, [3-3](#)
- torque wrench, [1-3](#)
 - specifications, [3-10](#)
- traceability
 - of device specifications, [4-2](#), [4-3](#)
- troubleshooting, flowchart, [5-2](#)

U

- user's and service guide
 - part number, [6-2](#)

V

- verification
 - performance, [4-3](#)
 - temperature, [2-2](#)
- visual inspection, [3-3](#)

W

- warranty, documentation, [ii](#)
- wear
 - connector, [3-3](#)
 - affect on electrical performance, [3-3](#)
- wrench
 - open-end, [1-3](#), [3-11](#), [3-12](#)
 - proper positioning of, [3-11](#)
 - torque, [1-3](#), [3-10](#), [3-11](#)
 - precautions for use of, [3-11](#)
 - proper use of, [3-11](#)

Z

- zeroing
 - connector gage, [3-8](#)