

Agilent N9398C/F/G and N9399C/F DC Block

Technical Overview

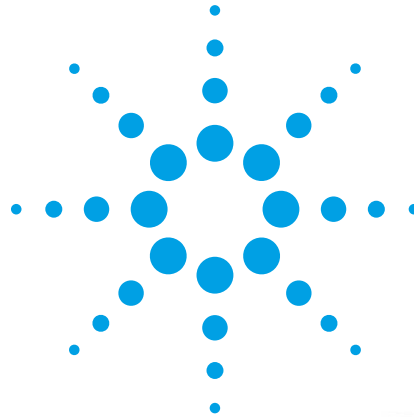

Key Features

- Maximize your operating range - 26.5, 50 or 67 GHz
- Improve calibration accuracy with exceptional return loss >15 dB at 67 GHz
- Maximum available power with < 0.9 dB insertion loss
- 2 choices of DC voltage ratings for a wide range of applications

Description

The Agilent N9398C/F/G and N9399C/F DC blocks offer a new level of DC blocking with broadband performance specified from 50 kHz right up to 67 GHz. Designed to apply AC drive signals to a device while eliminating any DC voltage or current components, these DC blocks feature a broad frequency range, excellent return loss, very low insertion loss and excellent temperature stability. Precision coaxial connector interfaces ensure an

excellent impedance match across wide bandwidths, and come in a variety of RF coaxial connector types (3.5 mm, 2.4 mm and 1.85 mm) to meet your application needs.

The Agilent N9398C/F/G and N9399C/F DC blocks are assembled and tested on Agilent precision network analyzers to assure full specifications over their entire frequency range.

Applications

Ruggedness and reliability make these DC blocks suitable for use on the bench and in systems. With low SWR and Insertion loss, they are ideally suited for suppressing DC signals which may affect the accuracy of your microwave and RF measurements or even damage your instruments.

The N9398C/F/G and N9399C/F DC blocks place the capacitance in series with the center conductor, preventing DC signals from flowing along the center conductor which can inadvertently bias other active components. These DC blocks provide good value with excellent broadband performance from 50 kHz to 50 GHz and 700 kHz to 67 GHz at a reasonable cost.

Sample Applications:

1. Amplifier Biasing

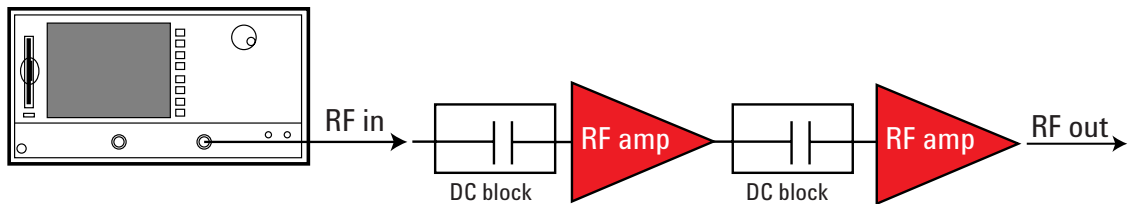

Figure 1. Typical application

DC blocks help prevent any DC signals entering the amplifier and creating a DC offset by acting as a high pass filter. A DC block also can be placed in between two RF amplifier stages to prevent any DC signal from the 1st stage entering the next amplifier stage.

2. Surge Arrestor

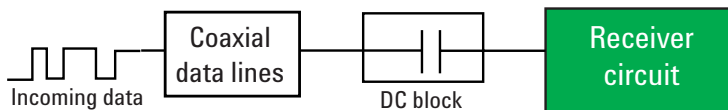

Figure 2. Typical application

Telecommunications based customers may use the DC blocks as surge arrestors before the incoming coaxial data lines are fed into their systems. Here the DC block protects the receiver circuit from any instantaneous voltage surge by absorbing the excess voltage.

Specifications

Specifications describe the product's warranted performance. Supplemental and typical characteristics are intended to provide typical but non-warranted performance parameters. These are denoted as "typical", "nominal" or "approximate".

Model	N9398C	N9399C	N9398F	N9399F	N9398G
Frequency range	50 kHz to 26.5 GHz	700 kHz to 26.5 GHz	50 kHz to 50 GHz	700 kHz to 50 GHz	700 kHz to 67 GHz
Insertion loss	0.9 dB	1.2 dB	0.9 dB (50 kHz to 26.5 GHz) 1.0 dB (26.5 to 50 GHz)	1.2 dB	0.9 dB (700 kHz to 26.5 GHz) 1.0 dB (26.5 to 67 GHz)
Return loss	10 dB (50 to 300 kHz) 17 dB (300 kHz to 26.5 GHz)	10 dB (700 kHz to 2 MHz) 17 dB (2 MHz to 26.5 GHz)	10 dB (50 to 300 kHz) 15 dB (300 kHz to 50 GHz)	10 dB (700 kHz to 2 MHz) 15 dB (2 MHz to 50 GHz)	10 dB (700 kHz to 2 MHz) 15 dB (2 MHz to 67 GHz)
Rise time	3 ps (typical)	3 ps (typical)	2 ps (typical)	2 ps (typical)	2 ps (typical)
Group delay	118 ps (typical)	118 ps (typical)	78 ps (typical)	78 ps (typical)	76 ps (typical)
Max DC working voltage	16 V	50 V	16 V	50 V	16 V
Connector type	3.5 mm (m-f)	3.5 mm (m-f)	2.4 mm (m-f)	2.4 mm (m-f)	1.85 mm (m-f)

Environmental Specifications

The N9398C/F/G and N9399C/F DC blocks are designed to fully comply with Agilent RF network and spectrum analyzers operating within environmental specifications. The following summarizes the environmental specifications for these products.

Temperature

Operating -25° C to +80° C (N9398C/F/G), -50° C to +100° C (N9399C/F)

Storage -65° C to +115° C (N9398C/F, N9399C/F),
-55° C to +100° C (N9398G)

Cycling -65° C to +115° C (N9398C/F, N9399C/F),
-55° C to +100° C (N9398G),
10 cycles @ 20° C per minute, 20 minutes dwell time per MIL-STD-833F, Method 1010.8, Condition C (modified)

Humidity

Operating 50% to 95% RH @ 40° C, 24 hour cycling, 5 times

Shock

Half-sine, smoothed 1000 G @ 0.5 ms, 3 shock pulses per orientation, 18 total per MIL-STD-833F, Method 2002.4, Condition B (modified)

Vibration

Broadband random 50 to 2000 Hz, 7.0 G rms, 15 minutes, per MIL-STD-833F, Method 2026-1 (modified)

Altitude

Storage < 15,300 meters (50,000 feet)

Mechanical Dimensions

Model	Weight
N9398/9C	0.1kg (0.22 lbs)
N9398/9F	0.1kg (0.22 lbs)
N9398G	0.1kg (0.22 lbs)

DC blocks N9398C and N9399C

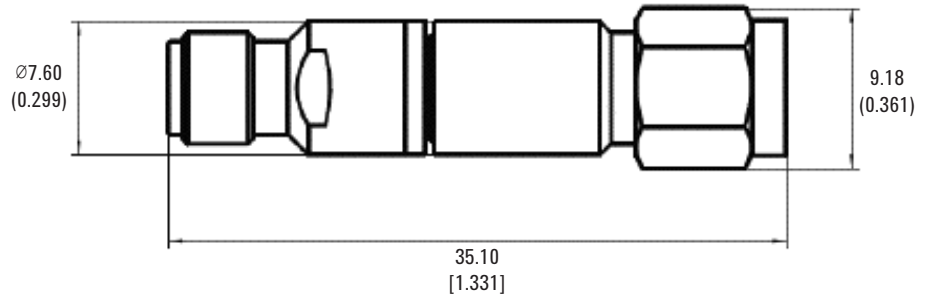

Figure 3. N9398/99C product outline

DC blocks N9398F and N9399F

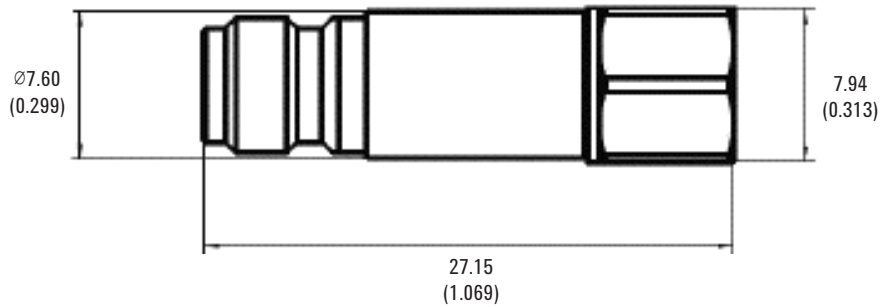

Figure 4. N9398/99F product outline

DC block N9398G

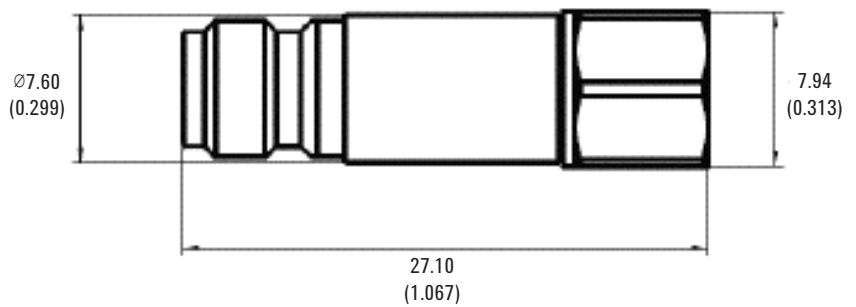

Figure 5. N9398G product outline

Dimensions are in mm (inches) nominal, unless otherwise specified.

Typical Performance

N9398C DC block return and insertion loss

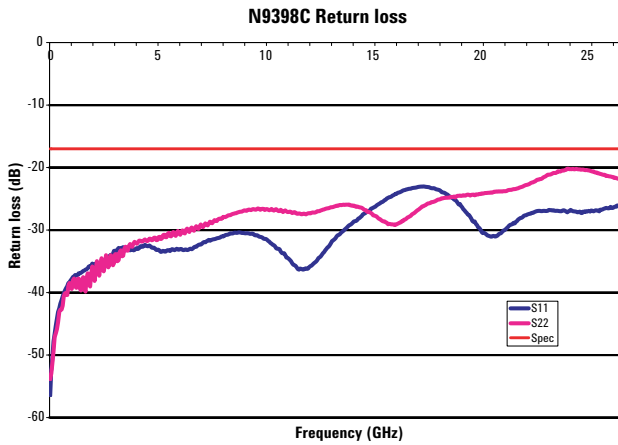

Figure 6. N9398C typical return loss versus frequency

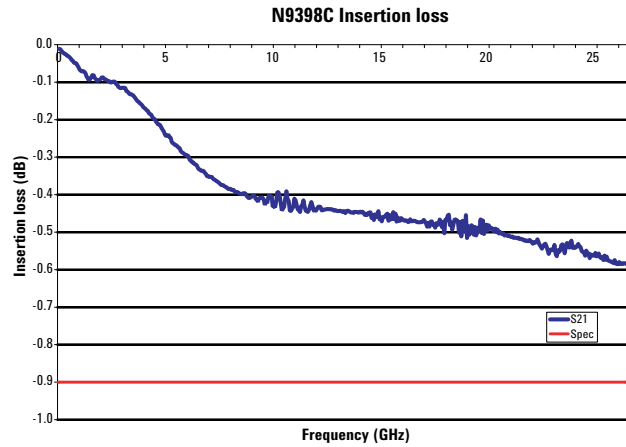

Figure 7. N9398C typical insertion loss versus frequency

N9399C DC block return and insertion loss

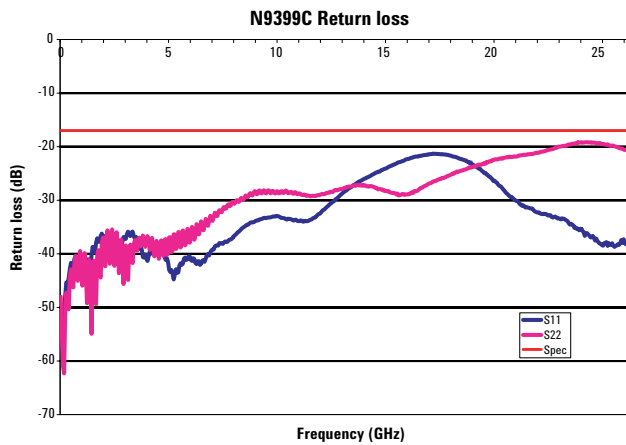

Figure 8. N9399C typical return loss versus frequency

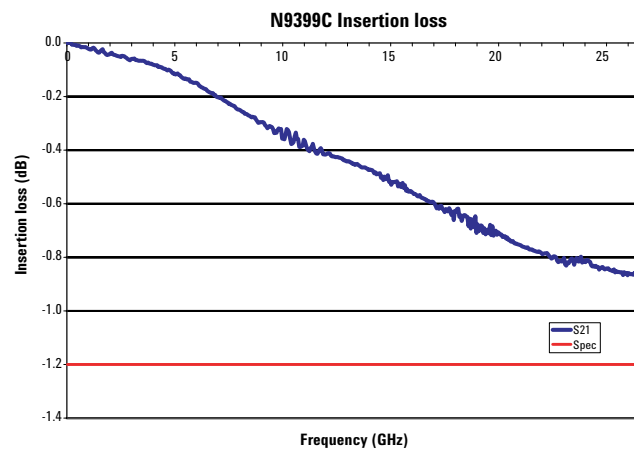

Figure 9. N9399C typical insertion loss versus frequency

Typical Performance – Continued

N9398F DC block return and insertion loss

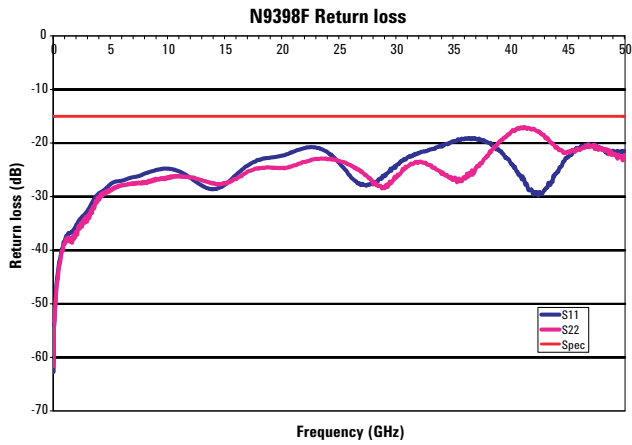

Figure 10. N9398F typical return loss versus frequency

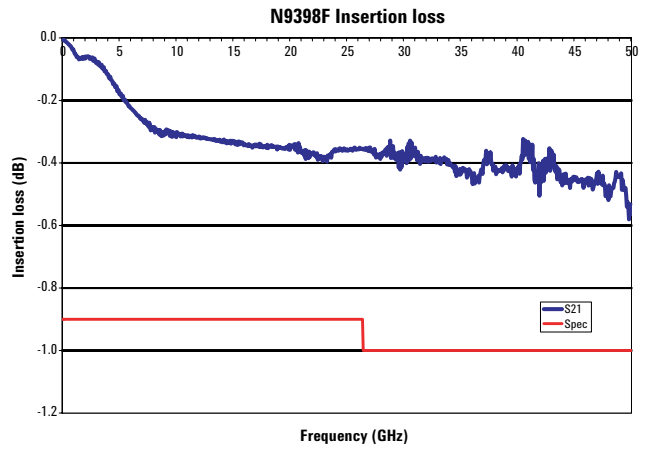

Figure 11. N9398F typical insertion loss versus frequency

N9399F DC block return and insertion loss

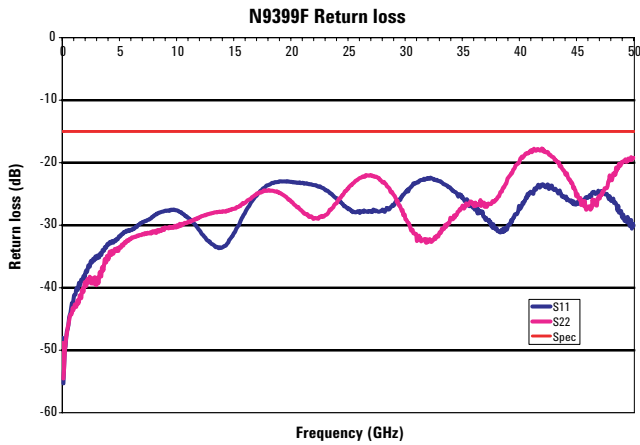

Figure 12. N9399F typical return loss versus frequency

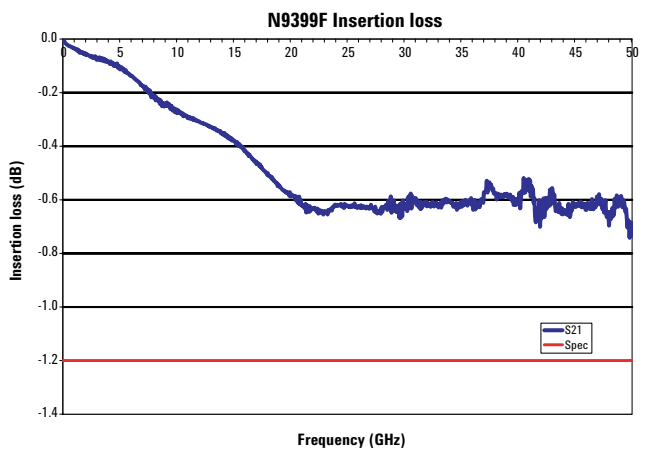

Figure 13. N9399F typical insertion loss versus frequency

Typical Performance – Continued

N9398G DC block return and insertion loss

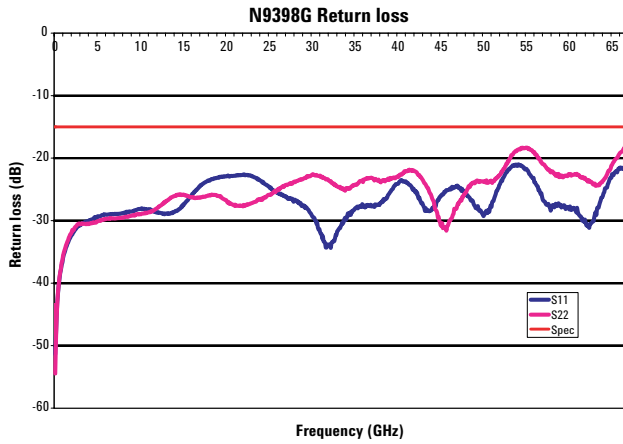

Figure 14. N9398G typical return loss versus frequency

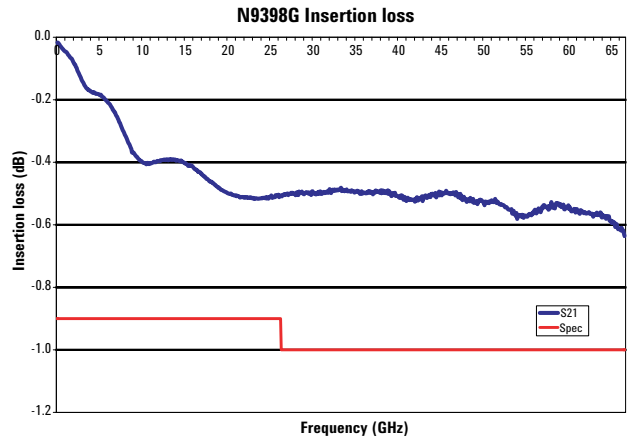

Figure 15. N9398G typical insertion loss versus frequency

Typical group delay

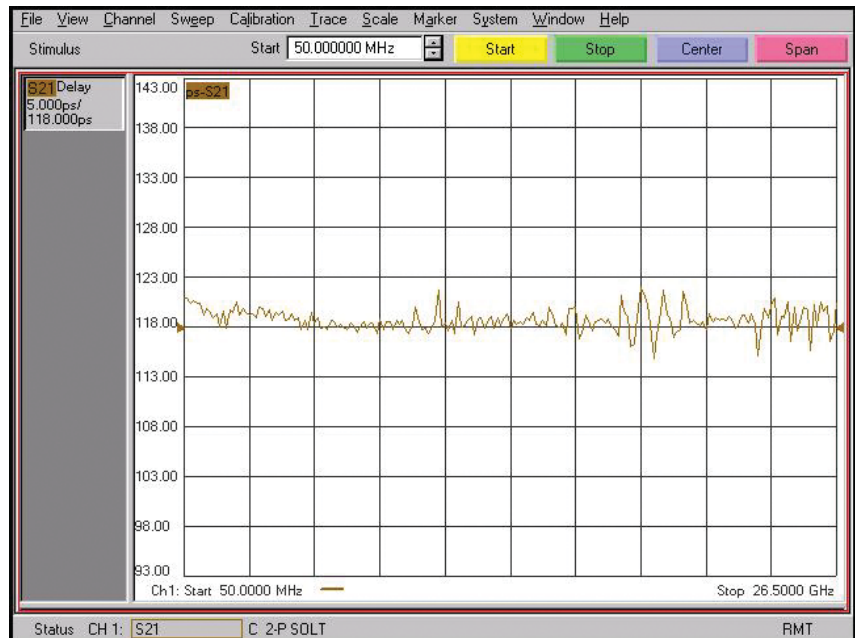

Figure 16. N9398C typical group delay

Typical Performance – Continued

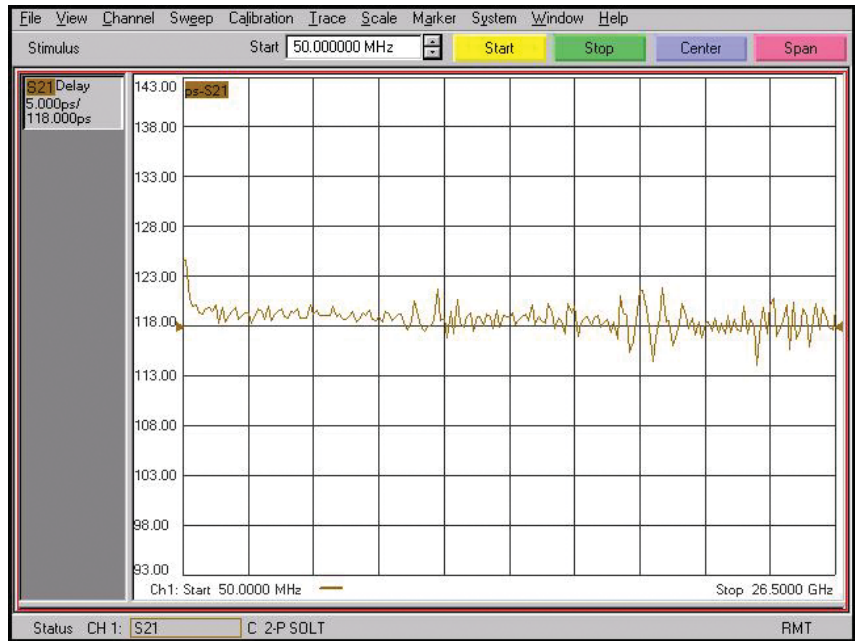

Figure 17. N9399C typical group delay

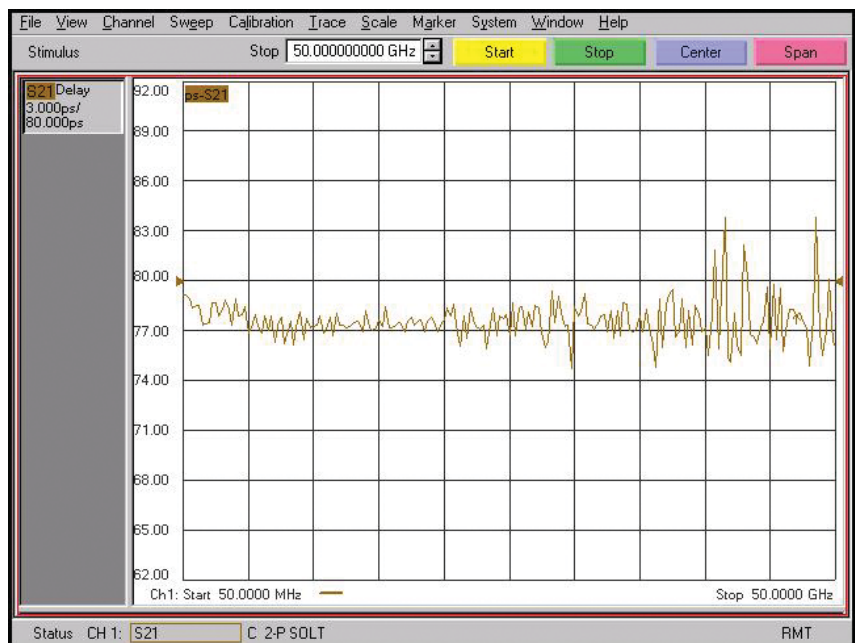

Figure 18. N9398F typical group delay

Typical Performance – Continued

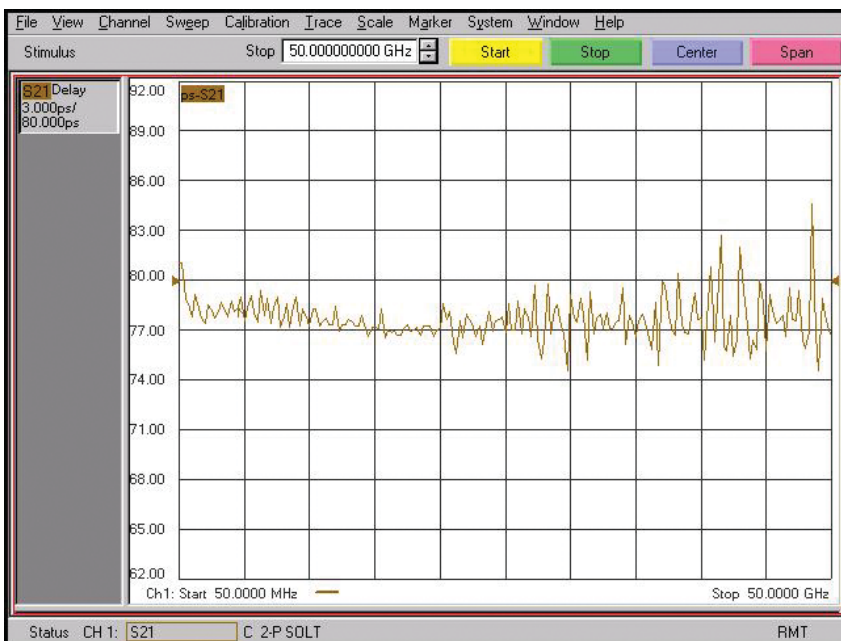

Figure 19. N9399F typical group delay

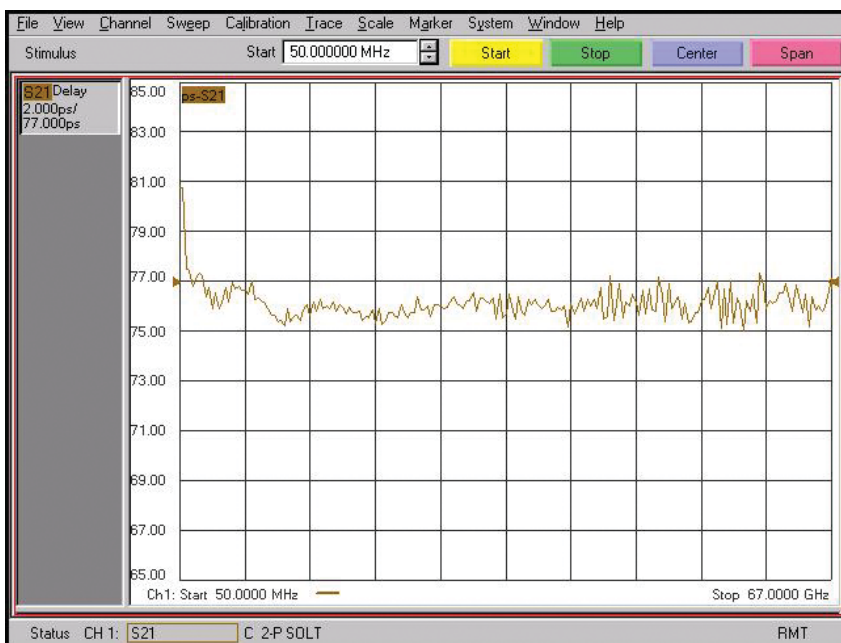

Figure 20. N9398G typical group delay

Ordering Information

N9398C	3.5 mm, 16 V 50 kHz to 26.5 GHz, DC block
N9399C	3.5 mm, 50 V 700 kHz to 26.5 GHz, DC block
N9398F	2.4 mm, 16 V 50 kHz to 50 GHz, DC block
N9399F	2.4 mm, 16 V 700 kHz to 50 GHz, DC block
N9398G	1.85 mm, 16 V 700 kHz to 67 GHz, DC block

Related Product Literature

Agilent N9398C/F/G and N9399C/F DC Blocks Flyer,
literature number 5989-5519EN

Web Resource

<http://www.agilent.com/find/mta>

 **Agilent Email Updates**

www.agilent.com/find/emailupdates

Get the latest information on the products and applications you select.

 **Agilent Direct**

www.agilent.com/find/quick

Quickly choose and use your test equipment solutions with confidence.

 **Agilent Open**

www.agilent.com/find/open

Agilent Open simplifies the process of connecting and programming test systems to help engineers design, validate and manufacture electronic products. Agilent offers open connectivity for a broad range of system-ready instruments, open industry software, PC-standard I/O and global support, which are combined to more easily integrate test system development.

LXI is the US registered trademark of the LXI Consortium.

Remove all doubt

Our repair and calibration services will get your equipment back to you, performing like new, when promised. You will get full value out of your Agilent equipment throughout its lifetime. Your equipment will be serviced by Agilent-trained technicians using the latest factory calibration procedures, automated repair diagnostics and genuine parts. You will always have the utmost confidence in your measurements.

Agilent offers a wide range of additional expert test and measurement services for your equipment, including initial start-up assistance onsite education and training, as well as design, system integration, and project management.

For more information on repair and calibration services, go to

www.agilent.com/find/removealldoubt

www.agilent.com

For more information on Agilent Technologies' products, applications or services, please contact your local Agilent office. The complete list is available at:

www.agilent.com/find/contactus

Phone or Fax

United States:

(tel) 800 829 4444
(fax) 800 829 4433

Canada:

(tel) 877 894 4414
(fax) 800 746 4866

China:

(tel) 800 810 0189
(fax) 800 820 2816

Europe:

(tel) 31 20 547 2111

Japan:

(tel) (81) 426 56 7832
(fax) (81) 426 56 7840

Korea:

(tel) (080) 769 0800
(fax) (080) 769 0900

Latin America:

(tel) (305) 269 7500

Taiwan:

(tel) 0800 047 866
(fax) 0800 286 331

Other Asia Pacific Countries:

(tel) (65) 6375 8100
(fax) (65) 6755 0042
Email: tm_ap@agilent.com

Revised: 09/14/06

Product specifications and descriptions in this document subject to change without notice.

© Agilent Technologies, Inc. 2006
Printed in USA, September 29, 2006
5989-4544EN



Agilent Technologies