

XR SERIES II

2 kW to 8 kW Programmable DC Power Supply

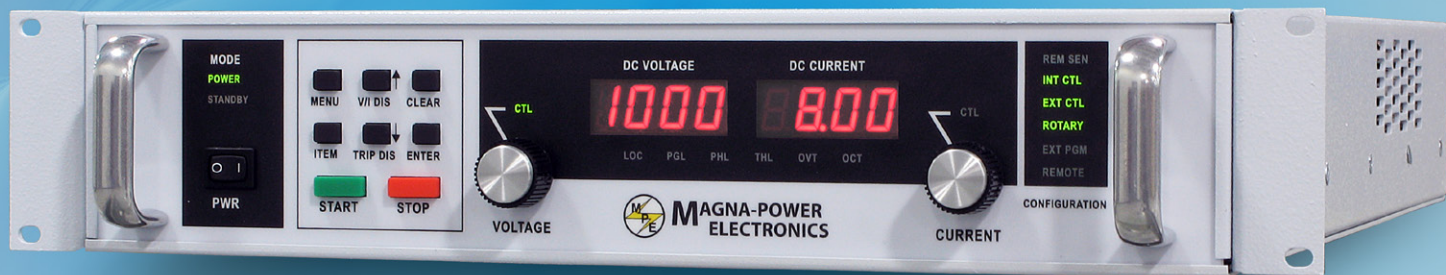

LXI CE

Highest Power Programmable DC Power Supply
available in a 2U Package



**MAGNA-POWER
ELECTRONICS**

www.magna-power.com

Rugged Current-Fed Technology

Innovative and Scalable

Magna-Power Electronics XR Series combines the best of DC power processing with *microprocessor embedded control*. Magna-Power Electronics' innovative power processing technology improves response, shrinks package size, and reduces cost. XR Series power supplies are *current-fed* and are more tolerant to abusive loads than conventional switching power supplies. This technology allows the power supply to operate under short-circuit conditions, open-circuit conditions, and everything inbetween.

XR Series power supplies offer both *master/slave parallel and series* operation. This enables two or more power supplies to be placed in parallel for increased output current or in series for increased output voltage. With master/slave operation, power supplies operate at near equal voltage and current.

XR Series power supplies can operate as a *voltage source* or *current source* depending on the control settings and load conditions. If the power supply is operating as a voltage source and the load increases to a point beyond the current command setting, the power supply automatically crosses over to current mode control and operates as a current source at that setting.

Attention to Power Quality

XR Series power supplies contain circuitry to work harmoniously with other power equipment. Step-start contactors are used to keep inrush current below full scale operating current. Filter components lower current harmonic content emanating from the power supply and increase power factor to levels beyond 90%. Every power supply is tested at 90% to 125% nominal line to insure satisfactory operation even under the worst line voltage conditions.

KEY FEATURES:

- **Highest power programmable 2U DC power supply:**
Up to 8 kW in a 2U package
- **Wide voltage and current range:**
0-16 Vdc to 0-1000 Vdc and 0-2 Adc to 0-375 Adc
- **Wide range of input voltages as standard:**
From 208 Vac to 480 Vac at 50 Hz, 60 Hz, and 400 Hz
- **Load dependent air cooling, 6 kW and 8 kW models:**
Variable speed fans proportional to loading
- **37-pin optically isolated user I/O circuitry standard:**
No additional isolation circuitry necessary
- **Front panel analog potentiometers:**
Stepless rotary control
- **High efficiency operation:**
Up to 88% efficiency on select models
- **RS232 interface standard with SCPI Commands:**
GPIB, USB, Ethernet, RS485 interfaces optional
- **Optional LXI-certified ethernet communications:**
Embedded web-server
- **OVT and OCT shutdown standard:**
Mechanical contactors disconnect input mains
- **Certified LabWindows/CVI, LabView, and IVI Drivers**
- **Programmable Output Modulation:**
Emulates user-defined power profiles
- **Automatic Voltage/Current Crossover**
- **Front Panel Calibration**

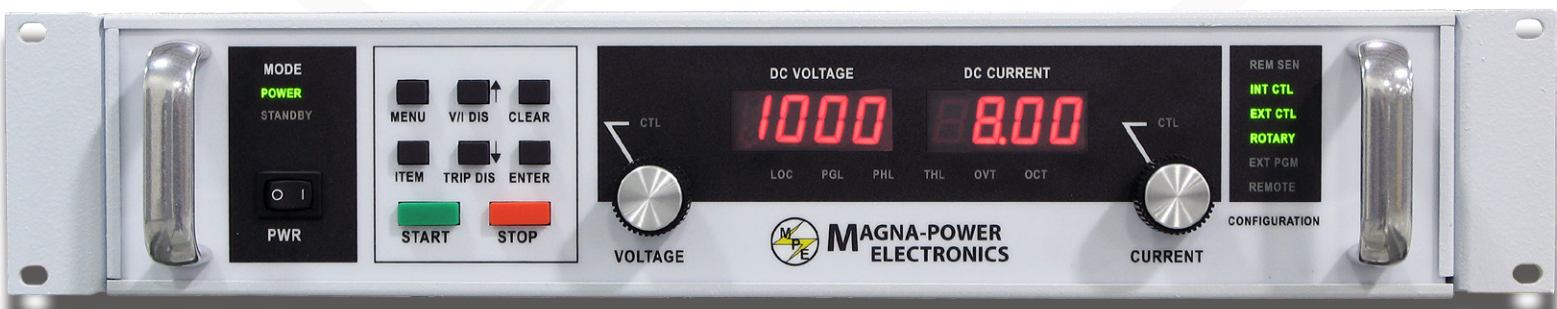

XR SERIES II

Models and Ratings



2 kW Models

Model	Voltage (Vdc)	Current (Adc)	Ripple (mVrms)	Eff. %	Input Current (Aac)		
					208/240 V	380/415 V	440/480 V
XR5-375	0-5	0-375	50	86	8.0	5.0	4.0
XR10-200	0-10	0-200	40	86	8.0	5.0	4.0
XR16-125	0-16	0-125	35	86	8.0	5.0	4.0
XR20-100	0-20	0-100	40	86	8.0	5.0	4.0
XR32-62	0-32	0-62	40	86	8.0	5.0	4.0
XR40-50	0-40	0-50	40	87	8.0	5.0	4.0
XR50-40	0-50	0-40	50	87	8.0	5.0	4.0
XR80-25	0-80	0-25	60	87	8.0	5.0	4.0
XR100-20	0-100	0-20	60	87	8.0	5.0	4.0
XR125-16	0-125	0-16	100	87	8.0	5.0	4.0
XR160-12	0-160	0-12	120	87	8.0	5.0	4.0
XR200-10	0-200	0-10	125	87	8.0	5.0	4.0
XR250-8	0-250	0-8	130	88	8.0	5.0	4.0
XR375-5.3	0-375	0-5.3	170	88	8.0	5.0	4.0
XR400-5.0	0-400	0-5.0	180	88	8.0	5.0	4.0
XR500-4.0	0-500	0-4.0	220	88	8.0	5.0	4.0
XR600-3.3	0-600	0-3.3	250	88	8.0	5.0	4.0
XR800-2.5	0-800	0-2.5	300	88	8.0	5.0	4.0
XR1000-2.0	0-1000	0-2.0	350	88	8.0	5.0	4.0

Note: Single phase input current: 16 Aac for 208/240 Vac input (2 kW models only)

4 kW Models

Model	Voltage (Vdc)	Current (Adc)	Ripple (mVrms)	Eff. %	Input Current (Aac)		
					208/240 V	380/415 V	440/480 V
XR10-375	0-10	0-375	40	86	15.0	9.0	8.0
XR16-250	0-16	0-250	35	86	15.0	9.0	8.0
XR20-200	0-20	0-200	40	86	15.0	9.0	8.0
XR32-124	0-32	0-124	40	86	15.0	9.0	8.0
XR40-100	0-40	0-100	40	87	15.0	9.0	8.0
XR50-80	0-50	0-80	50	87	15.0	9.0	8.0
XR80-50	0-80	0-50	60	87	15.0	9.0	8.0
XR100-40	0-100	0-40	60	87	15.0	9.0	8.0
XR125-32	0-125	0-32	100	87	14.0	9.0	8.0
XR160-24	0-160	0-24	120	87	14.0	9.0	8.0
XR200-20	0-200	0-20	125	87	14.0	9.0	8.0
XR250-16	0-250	0-16	130	88	14.0	9.0	8.0
XR375-10.6	0-375	0-10.6	170	88	14.0	9.0	8.0
XR400-10.0	0-400	0-10.0	180	88	14.0	9.0	8.0
XR500-8.0	0-500	0-8.0	220	88	14.0	9.0	8.0
XR600-6.6	0-600	0-6.6	250	88	14.0	9.0	8.0
XR800-5.0	0-800	0-5.0	300	88	14.0	9.0	8.0
XR1000-4.0	0-1000	0-4.0	350	88	14.0	9.0	8.0

Options

Title	Option Code
LXI TCP/IP Ethernet Interface (Internal)	+LXI
Cabinet and Integration	+CAB1, +CAB2, +CAB3
IEEE 488.2 GPIB Interface (Internal)	+GPIB
USB Edgeport Interface (External)	+USB
RS-485DSS Interface (External)	+RS485
UID46: Universal Interface Device	+UID46
208/240 Vac single-phase input (5 kW)	SP

6 kW Models

Model	Voltage (Vdc)	Current (Adc)	Ripple (mVrms)	Eff. %	Input Current (Aac)		
					208/240 V	380/415 V	440/480 V
XR16-375	0-16	0-375	35	86	22.0	13.0	11.0
XR20-300	0-20	0-300	40	86	22.0	13.0	11.0
XR32-186	0-32	0-186	40	86	22.0	13.0	11.0
XR40-150	0-40	0-150	40	87	22.0	13.0	11.0
XR50-120	0-50	0-120	50	87	22.0	13.0	11.0
XR80-75	0-80	0-75	60	87	22.0	13.0	11.0
XR100-60	0-100	0-60	60	87	22.0	13.0	11.0
XR125-48	0-125	0-48	100	87	21.0	13.0	11.0
XR160-36	0-160	0-36	120	87	21.0	13.0	11.0
XR200-30	0-200	0-30	125	87	21.0	13.0	11.0
XR250-24	0-250	0-24	130	88	21.0	13.0	11.0
XR375-15.9	0-375	0-15.9	170	88	21.0	13.0	11.0
XR400-15.0	0-400	0-15.0	180	88	21.0	13.0	11.0
XR500-12	0-500	0-12	220	88	21.0	13.0	11.0
XR600-9.9	0-600	0-9.9	250	88	21.0	13.0	11.0
XR800-7.5	0-800	0-7.5	300	88	21.0	13.0	11.0
XR1000-6.0	0-1000	0-6.0	350	88	21.0	13.0	11.0

8 kW Models

Model	Voltage (Vdc)	Current (Adc)	Ripple (mVrms)	Eff. %	Input Current (Aac)		
					208/240 V	380/415 V	440/480 V
XR20-375	0-20	0-375	60	86	29.0	17.0	15.0
XR32-250	0-32	0-250	60	86	29.0	17.0	15.0
XR40-200	0-40	0-200	60	86	29.0	17.0	15.0
XR50-160	0-50	0-160	70	87	29.0	17.0	15.0
XR80-100	0-80	0-100	80	87	29.0	17.0	15.0
XR100-80	0-100	0-80	80	87	29.0	17.0	15.0
XR125-64	0-125	0-64	120	87	29.0	17.0	15.0
XR160-50	0-160	0-50	125	87	28.0	17.0	15.0
XR200-40	0-200	0-40	120	87	28.0	17.0	15.0
XR250-32	0-250	0-32	140	87	28.0	17.0	15.0
XR375-21.3	0-375	0-21.3	200	88	28.0	17.0	15.0
XR400-20.0	0-400	0-20.0	220	88	28.0	17.0	15.0
XR500-16.0	0-500	0-16.0	240	88	28.0	17.0	15.0
XR600-13.3	0-600	0-13.3	280	88	28.0	17.0	15.0
XR800-10.0	0-800	0-10.0	320	88	28.0	17.0	15.0
XR1000-8.0	0-1000	0-8.0	380	88	28.0	17.0	15.0

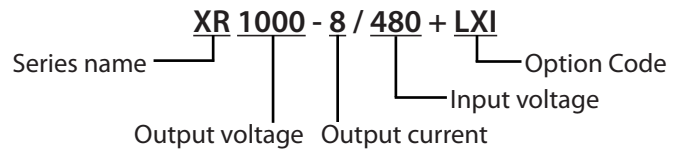

Model Ordering System

Series Name	Front Panel	Output Voltage	Output Current	Input Voltage	Option Code(s)
XR	A: Analog	See Tables	See Tables	208 SP	+LXI
				240 SP	+CAB1, +CAB2, +CAB3
				208	+GPIB
				240	+USB
				380	+RS485
TS	D: Digital	See Tables	See Tables	415	+HS
				440	+UID46
				480	SP
MS	C: Computer	See Tables	See Tables		
MT	Blank: XR				

XR SERIES II

Specifications



Input

Nominal Voltage	208 VAC, 3 ϕ (operating range 187 - 229 VAC) 240 VAC, 3 ϕ (operating range 216 - 264 VAC)
3 phase, 3 wire + ground	380 VAC, 3 ϕ (operating range 342 - 418 VAC) 415 VAC, 3 ϕ (operating range 373 - 456 VAC) 440 VAC, 3 ϕ (operating range 396 - 484 VAC) 480 VAC, 3 ϕ (operating range 432 - 528 VAC)
1 phase, 2 wire + ground (2 kW models only)	208 VAC, 1 ϕ (operating range 187 - 229 VAC) 240 VAC, 1 ϕ (operating range 216 - 264 VAC)
Frequency	50 Hz through 400 Hz
Power Factor	Greater than 92% at maximum power

Environmental

Operating Temperature	0 °C to 50 °C
Storage Temperature	-25 °C to 85 °C
Temperature Coefficient	0.04 / °C of maximum output current
Air Cooling	Side air inlet, rear exhaust

Physical

Power (kW)	Size (H" x W" x D")	Rack Units	Weight
2 kW	3.50 x 19 x 24 in (8.89 x 48.3 x 61.0 cm)	2U	45 lbs (20.41 kg)
4 kW	3.50 x 19 x 24 in (8.89 x 48.3 x 61.0 cm)	2U	47 lbs (21.32 kg)
6 kW	3.50 x 19 x 24 in (8.89 x 48.3 x 61.0 cm)	2U	48 lbs (21.77 kg)
8 kW	3.50 x 19 x 24 in (8.89 x 48.3 x 61.0 cm)	2U	48 lbs (21.77 kg)

Control Limits

Remote Sense Limits	3% maximum voltage drop from output to load
Digital control inputs and outputs limits	Input voltage: 0 to 5 V Output voltage: 0 to 5 V, 5 mA drive capacity

Experience you can rely on.

Our products have evolved by listening to our customers and working with them to find solutions to their problems. Our continual growth is based upon our innovative engineering, superior manufacturing methods, and dedicated employees. Today, all engineering and manufacturing is performed in Flemington, NJ.

Output

Ripple	See Model Charts
Line Regulation	Voltage Mode: $\pm 0.004\%$ of full scale Current Mode: $\pm 0.02\%$ of full scale
Load Regulation	Voltage Mode: $\pm 0.01\%$ of full scale Current Mode: $\pm 0.04\%$ of full scale
Load Transient Response	2 ms to recover within $\pm 1\%$ of regulated output, with a 50% to 100% or 100% to 50% step load change
Efficiency	$\geq 86\%$ (See Model Charts)
Stability	$\pm 0.10\%$ for 8 hrs. after 30 min. warmup
Isolation	Maximum input voltage to ground: ± 2500 VAC Maximum output voltage to ground: ± 1000 VDC User inputs and outputs: Referenced to earth ground
Maximum Slew Rate	Standard Models: 100 ms for output voltage change from 0 to 63% 100 ms for output voltage change from 0 to 63% With High Slew Rate Option: 4 ms for output voltage change from 0 to 63% 8 ms for output voltage change from 0 to 63%
Bandwith	Standard Models: 3 Hz with remote analog voltage programming, 2 Hz with remote analog current programming. With High Slew Rate Option: 90 Hz with remote analog voltage programming, 60 Hz with remote analog current programming.
Analog Output Impedances	Voltage output monitoring: 100 ohm, Current output monitoring: 100 ohm, +10V Ref: 1 ohm.

Programming Levels and Accuracy of Full Scale

	Voltage Set Point	Current Set Point	OVT Set Point	OCT Set Point
Remote Analog Programming Accuracy	$\pm 0.50\%$	$\pm 0.75\%$	$\pm 0.50\%$	$\pm 0.75\%$
Digital Programming Accuracy	$\pm 0.50\%$	$\pm 0.75\%$	$\pm 0.50\%$	$\pm 0.75\%$
Remote Analog Programming Levels	0 - 10.0 V	0 - 10.0 V	0 - 10.0 V	0 - 10.0 V

Monitoring Levels and Accuracy of Full Scale

	Output Voltage	Output Current
Remote Analog Monitoring Accuracy	$\pm 0.50\%$	$\pm 0.75\%$
Digital Monitoring Accuracy	$\pm 0.50\%$	$\pm 0.75\%$
Remote Analog Monitoring Levels	0 - 10.0 V	0 - 10.0 V

Note: Specifications are subject to change without notice. For three-phase configurations, specifications are line-to-neutral. Unless otherwise noted, input voltages and currents are specified for three-phase configurations.

XR SERIES II

Reliable Control Technology

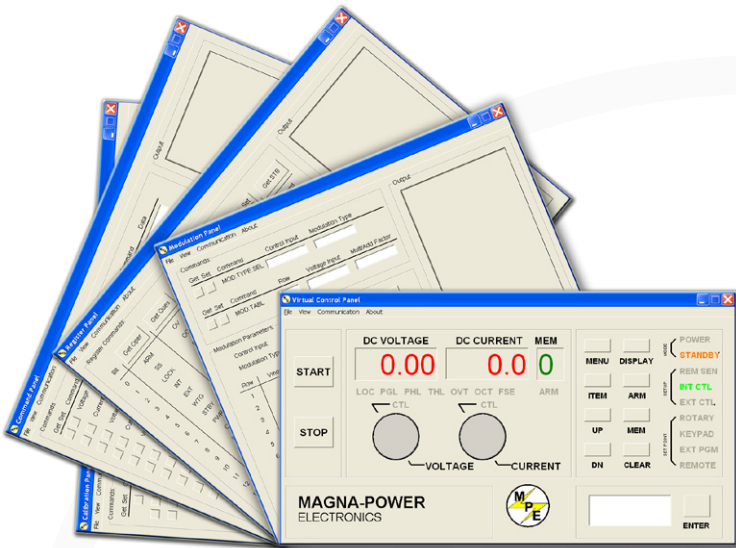

Remote Interface Software

The Remote Interface Software ships with all XR Series power supplies. The software provides the user with an easy and intuitive method to operate a Magna-Power Electronics' power supply with computer control. The Remote Interface Software has six windows:

- Virtual Control Panel
- Command Panel
- Register Panel
- Calibration Panel
- Firmware Panel
- Modulation Panel

The Virtual Control Panel emulates the XR Series front panel, the Command panel programs and reads SCPI commands with user friendly buttons, the Register Panel programs and reads registers, the Calibration Panel enables calibration of the digital potentiometers, the Firmware Panel enables the program stored internal to the power supply to be upgraded, and the Modulation Panel eases programming of modulation parameters.

Power Source Emulation

Output modulation enables Magna-Power Electronics' power supplies to emulate a variety of user-defined power sources, such as *Fuel Cells*, *Photovoltaic Arrays*, *Batteries*, etc. The power supplies follow an I-V curve programmed either through Magna-Power's Remote Interface Software (modulation panel), LabVIEW with certified NI LabVIEW drivers, or through other programming means using SCPI commands.

Isolated External I/O for Automation

Using the rear 37-pin I/O connector, the XR Series power supplies can be completely controlled and monitored using external signals. The voltage, current, over voltage trip, and over current trip set points are set by applying a 0-10 Vdc analog signals. Each diagnostic condition is given a designated pin, which reads 5 Vdc when high. Also, the power supply features an external interlock, which when enabled, allows the power supply to be tied in with other emergency stop equipment. All these pins are isolated to earth-ground as standard--no additional isolation circuitry necessary!

LXI-Compliant Embedded Ethernet

LXI is an instrumentation platform based on industry standard Ethernet technology designed to provide modularity, flexibility and performance to small- and medium-sized systems. LXI's advantages are exemplified in its compact, flexible package providing high-speed I/O and reliable measurements. These features meet the needs of R&D and manufacturing engineers delivering electronics for the aerospace/defense, automotive, industrial, and medical markets.



Certified to the LXI Standard (Class C), the XR Series Ethernet option includes an embedded web-server, allowing web browser power supply control and monitoring from virtually anywhere.

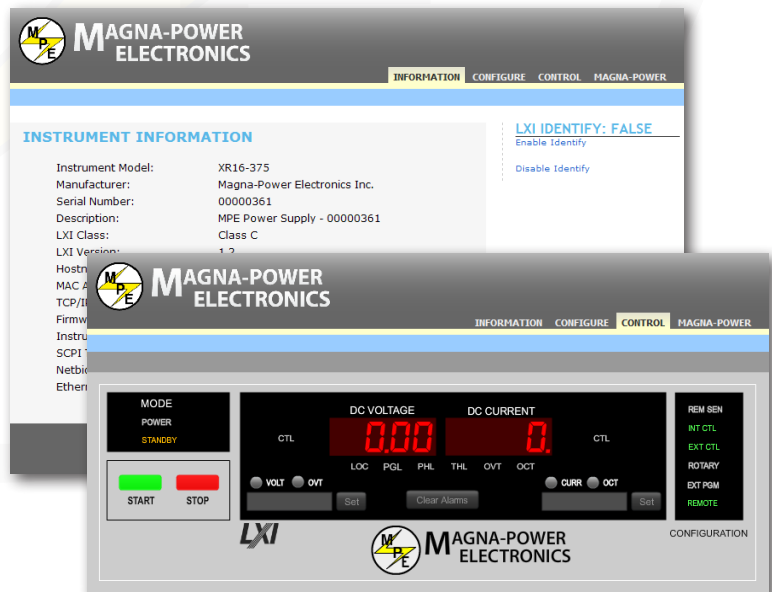

XR SERIES II

Enhanced Front Panel Control

Standard Front Panel

XR models provide stepless analog control from front panel potentiometers. With a simple configuration change, the power supply can be programmed from the rear I/O connector or through software on one of the communication buses.

Computer Control: C Version Front Panel

XR models utilizing the C Version front panel, XRC, only allows control from the rear I/O connector or by RS232/GPIB/USB/Ethernet communications. These models are intended for process control applications where front panel controls and displays are not required nor desired.

Standard Front Panel

FUNCTION KEYS:

MENU: Select function
V/I DIS: Displays voltage and current setting
CLEAR: Clear setting or reset fault condition
ITEM: Select item within function
TRIP DIS: Displays OVT and OCT setting
ENTER: Enter Setting

Meters display voltage, current, over voltage trip, over current trip

ALARMS:

LOC: Interlock
PGL: External input beyond limits
PHL: Indicates a problem with the input voltage
THL: Indicates overheating
OVT: Shows over voltage protection has tripped
OCT: Show over current protection has tripped

CONFIGURATION:

REM SEN: Indicates remote sense
INT CTL: Front panel controls enabled
EXT CTL: External controls enabled
ROTARY: Potentiometer voltage/current control
EXT PGM: External voltage/current control
REMOTE: RS232 control enabled

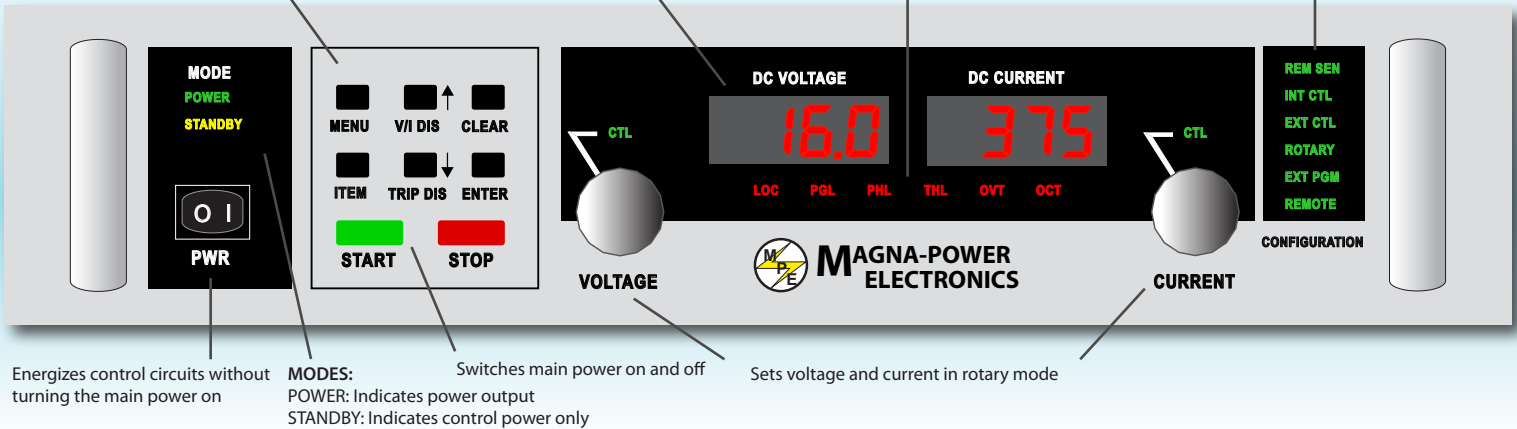

Energizes control circuits without turning the main power on

MODES:
POWER: Indicates power output
STANDBY: Indicates control power only

Switches main power on and off

Sets voltage and current in rotary mode

C Version Front Panel



Energizes control circuits without turning the main power on

XR SERIES II

Size Diagrams

Front Panel

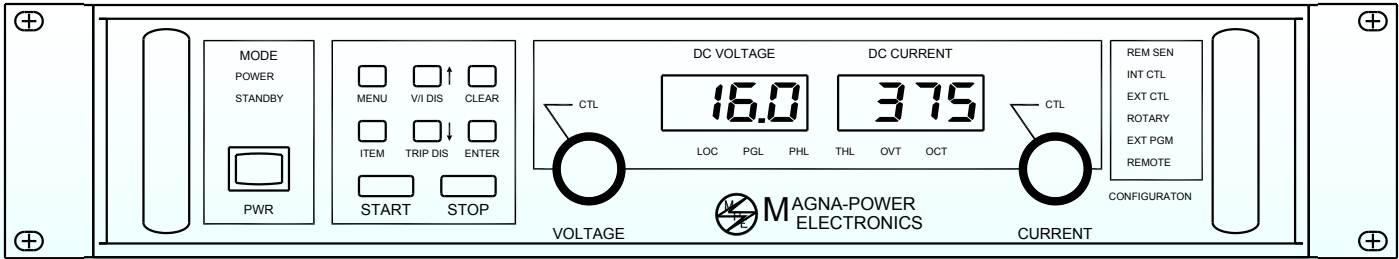

Rear Panel

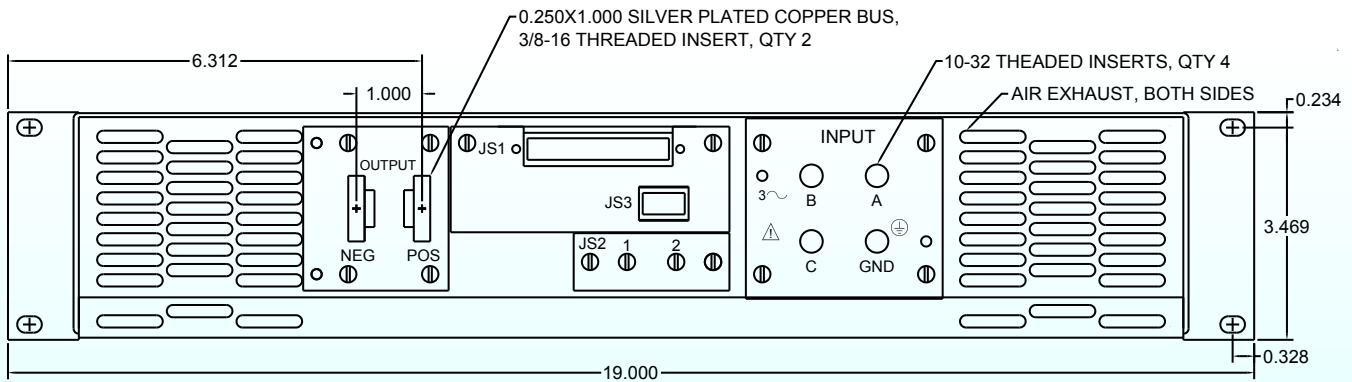

Side Panel

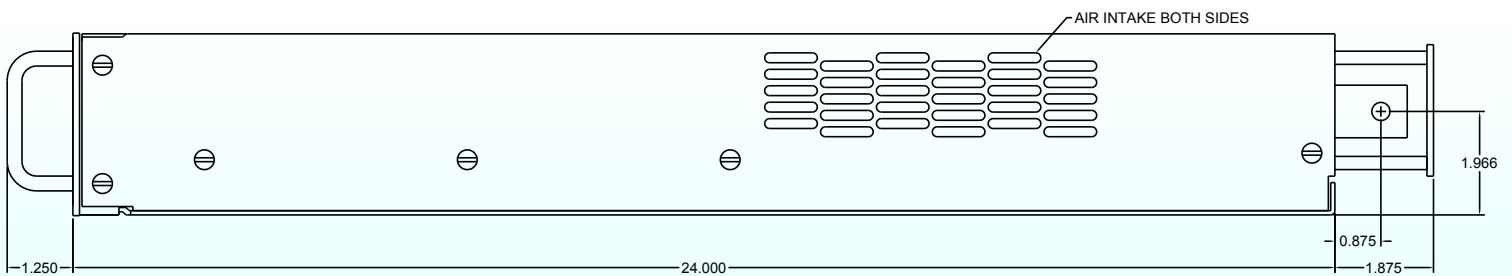

Interfaces

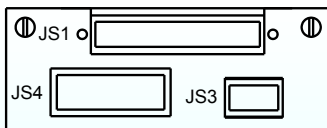

OPTIONAL IEEE-488
INTERFACE

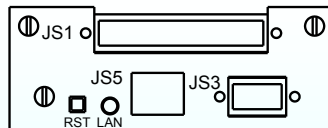

OPTIONAL ETHERNET
INTERFACE

Connector JS1

TERM	PARAMETER	TERM	PARAMETER
1	REF GND	20	REF GND
2	REF GND	21	+10V REF
3	VREF EXT	22	IREF EXT
4	TVREF EXT	23	TIREF EXT
5	VO2	24	IO2
6	+2.5V REF CAL	25	VMOD
7	GND	26	+5V
8	POWER	27	PGM LINE
9	THERMAL	28	STANDBY
10	INTERLOCK	29	PHASE LOSS
11	CUR CTL	30	VOLT CTL
12	STANDBY/ALM	31	RESERVE
13	ALM	32	OCT
14	EXT CTL	33	INT CTL
15	RESERVE	34	OVT
16	RESERVE	35	RESERVE
17	START	36	RESERVE
18	CLEAR	37	INTERLOCK SET
19	STOP		

Connector JS2

TERM	PARAMETER
1	VO1REM-
2	VO1REM+

Connector JS3

TERM	PARAMETER
1	NC
2	RX
3	TX
4	DTR
5	GND
6	DSR
7	RTS
8	CTS
9	NC

Power Supply Applications

Automated Test Equipment (ATE)

High power density and isolated rear I/O make the XR Series the ideal DC power source for rackmount systems. The analog I/O port allows you to connect a programmable logic controller or other external controls to set voltage, current, trip points, and monitor all the power supply's diagnostics using industry standard +5 Vdc signals.

Automotive Drive Testing / Burn-in

Whether for developing hybrid / electric powertrains or testing and burning-in electric motors, our DC supplies are proven in the automotive industry. With high current capabilities, transient response, and robust safety features, our power supplies are applied to a large number of automotive applications.

Water Treatment, Electrolysis, and Chemical Processes

Low ripple, excellent controls, and high reliability make the XR Series a solid choice for applications in electrodeionization (EDI) and electrolysis. Our supplies can be found around the world powering EDI modules. For hydrogen production, high efficiency and advanced diagnostics make the XR Series a smart choice.

Research at Universities and National Labs

Magna-Power Electronics' products can be found in research facilities, universities, and national laboratories around the globe. Our wide range of output voltages, robust current-fed power processing technology, and commitment to our customers and their applications have differentiated us from the competition.

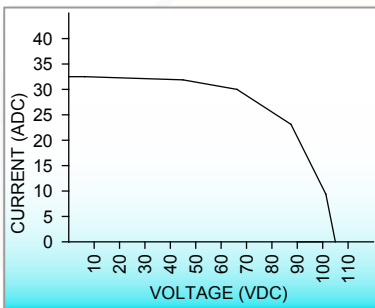

Power Source Emulation

Modulation enables the power supply to emulate different sources: such as batteries, fuel cells, photovoltaic arrays, etc. This emulation is accomplished by programming the output voltage or current to respond to an input variable using the Remote Interface Panel or with SCPI commands. The figure on the left illustrates the programmed piecewise linear approximation for a typical photovoltaic array. Alternatively, an I-V curve can be set using LabView using Magna-Power Electronics certified Labview drivers.

IV characteristics for a typical photovoltaic array

Battery Charging

A temperature compensated battery charger for applications with lead acid batteries. Diode D1, placed between the power supply and battery, blocks current from flowing from the battery to the power supply. This eliminates any loading on the battery when the power supply is off and prevents the battery from charging the power supply's output capacitors. Remote sensing should be applied across the battery terminals to compensate for the diode drop. By setting the voltage and current to the bulk charge voltage and maximum charge current, the power supply will initially charge the batteries in current mode control and then automatically crossover to voltage mode control when the batteries reach the desired set point. The power supply can be programmed for time dependent, sequential step operation to equalize and float charge the batteries after bulk charging.

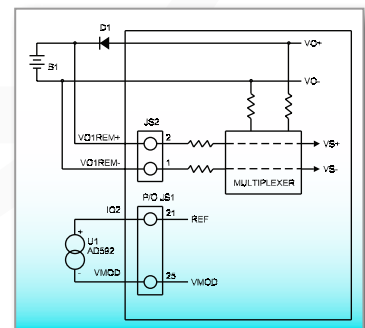

Temperature compensated battery charger