

# Series 2600A

# System SourceMeter® Instruments

- Combines a power supply, true current source, DMM, arbitrary waveform generator, V or I pulse generator with measurement, electronic load, and trigger controller – all in one instrument
- Family of products offers wide dynamic range: 1fA to 10A and 1µV to 200V
- 20,000 rdg/s provides faster test times and ability to capture transient device behavior
- Precision timing and channel synchronization (<500ns)
- USB port for saving data and test scripts
- LXI Class C compliance supports high speed data transfer and enables quick and easy remote testing, monitoring, and troubleshooting
- Software:
  - – TSP® Express for quick and easy I-V test (embedded)
  - – ACS Basic Edition for semiconductor component characterization (optional)



Series 2600A System SourceMeter instruments are Keithley's latest I-V source-measure instruments for use as either bench-top I-V characterization tools or as building block components of multi-channel I-V test systems. For bench-top use, Series 2600A instruments feature an embedded TSP Express Software Tool that allows users to quickly and easily perform common I-V tests without programming or installing software. For system level applications, Series 2600A's Test Script Processor (TSP) architecture along with other new capabilities such as parallel test execution and precision timing provides the highest throughput in the industry, lowering the cost of test. To simplify the testing, verification, and analysis of semiconductor components, the optional ACS Basic Edition software is also available.

Series 2600A System SourceMeter instruments replace the popular Series 2600 System SourceMeter instruments with a superset of features. 2600A instruments readily execute all 2600 commands.

### CONNECT DUT

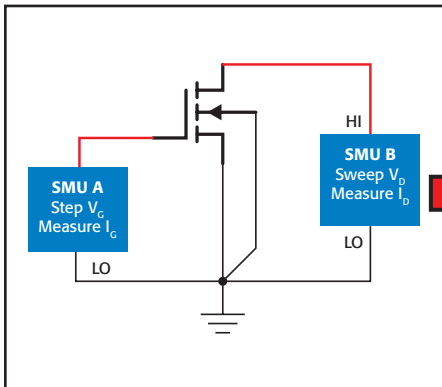

### CONFIGURE Test

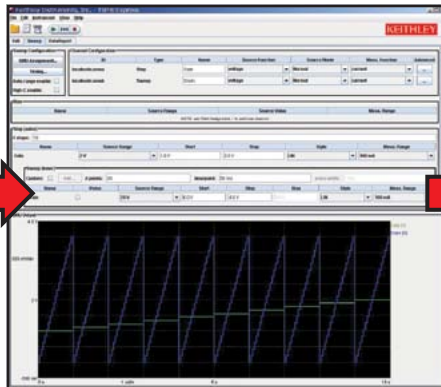

### COLLECT Data



Performing nested sweeps to characterize a transistor with TSP Express is quick and easy. Data can be exported to a .csv file for use with spreadsheet applications such as Excel.

### Quick and Easy Lab and Bench-Top Use

Each Series 2600A SourceMeter instrument is a complete I-V measurement solution with unmatched ease of use, capability, and flexibility. They simplify the process of making high-performance measurements.

The TSP Express Software Tool quickly sets up and runs basic and advanced tests, including: nested step/sweeps, pulse sweeps, and custom sweeps for device characterization applications. The resulting data can be viewed in graphical or tabular format and exported to a .csv file for use with spreadsheet applications.

TSP Express runs on a PC connected to the SourceMeter instrument via an Ethernet cable (provided with the instrument). The intuitive user interface resides on the built-in LXI web page, so no software installation is needed.

## Simplify Semiconductor Component Test, Verification, and Analysis

The optional ACS Basic Edition software maximizes the productivity of customers who perform packaged part characterization during development, quality verification, or failure analysis, with:

- Rich set of easy-to-access test libraries
- Script editor for fast customization of existing tests
- Data tool for comparing results quickly
- Formulator tool that analyzes captured curves and provides a wide range of math functions

For more information about the ACS Basic Edition software, please refer to the ACS Basic Edition data sheet.

## Unmatched Throughput and Flexibility for High Performance I-V Test Systems

TSP technology provides remarkable capabilities when a Series 2600A is integrated as part of a multi-channel I-V test system.

For example, the embedded scripting capability allows test scripts to be run by the instrument. Test scripts are complete test programs based on an easy to use but highly efficient and compact scripting language called Lua <[www.lua.org](http://www.lua.org)>. Since test scripts can contain any sequence of routines that are executable by conventional programming languages (including decision making algorithms), this feature allows entire tests to be managed by the instrument without sending readings back to a PC for decision making. This eliminates the delays caused by GPIB traffic congestion and greatly improves overall test times.

Also, TSP technology offers “mainframe-less channel expansion.” The TSP-Link channel expansion bus (which uses a 100 Base T Ethernet cable) allows multiple Series 2600A and other TSP instruments to be connected in a master-slave configuration and behave as one integrated system. TSP-Link supports up to 32 units or 64 SMU channels per GPIB or IP address, making it easy to scale a system to fit the particular requirements of an application.

## Parallel Test Capability

The Series 2600A takes system level performance to a new height with parallel testing capability. This feature tests multiple devices in parallel to meet the high throughput requirements of production test and advanced semiconductor lab applications.

This parallel testing capability enables each instrument in the system to run its own complete test sequence, creating a fully multi-threaded test environment. Hence, the number of tests that can be running in parallel on a Series 2600A system can be as many as the number of instruments in the system. In contrast, most conventional test systems run a single thread test, usually on the controller

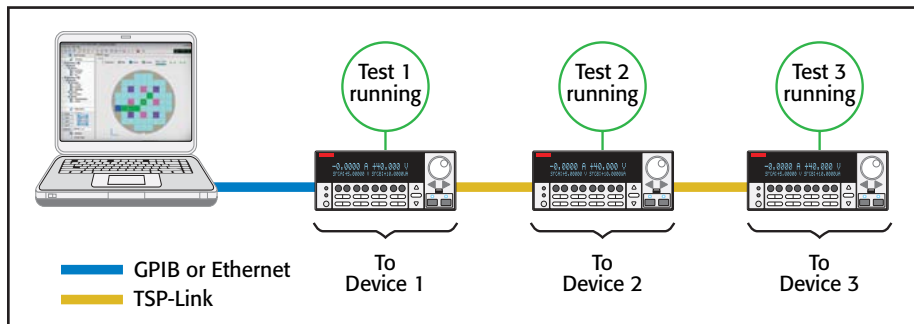

Parallel testing with the Series 2600A

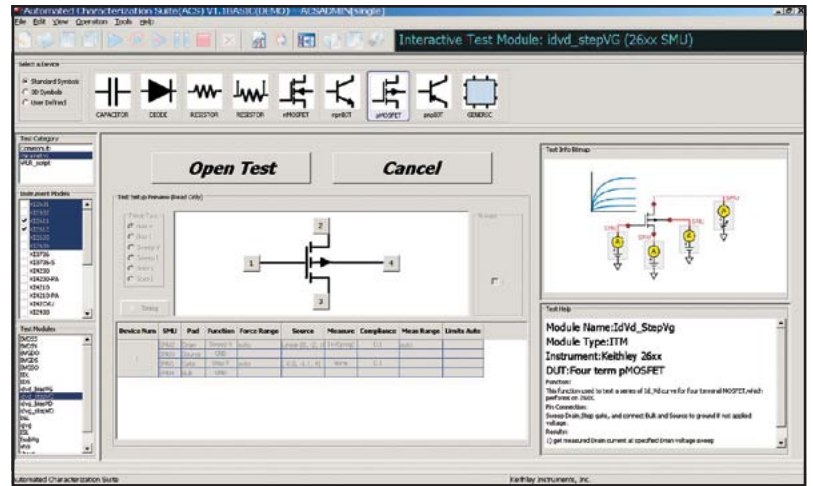

When you need to acquire data on a packaged part quickly, the wizard-based user interface of ACS Basic Edition makes it easy to find and run the test you want, like this common FET curve trace test.

PC instead of the instrument itself. Testing multiple devices at the same time means dramatically improved test throughput and reduced overall cost of test.

When all or some of your test requirements change, your Series 2600A system can be reconfigured via software without rewiring. The internal software can match the different pin layouts of the devices-under-test to the appropriate SMU-per-pin configurations.

## Tight Timing and Synchronization

Today's test engineers are challenged with testing increasingly more complex and more sensitive devices that require precise timing and synchronization. Whether you need to synchronize electrical and optical tests for an

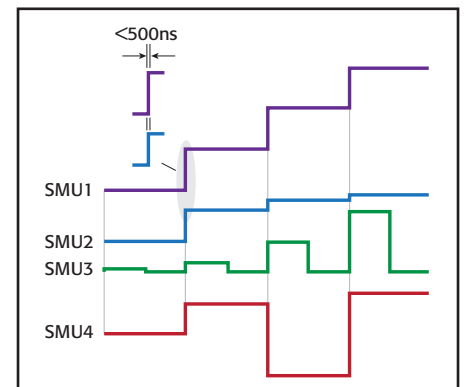

All channels in the system are synchronized to under 500ns.

# Series 2600A

## System SourceMeter® Instruments

### Ordering Information

2601A	Single-channel System SourceMeter Instrument (3A DC, 10A Pulse)
2602A	Dual-channel System SourceMeter Instrument (3A DC, 10A Pulse)
2611A	Single-channel System SourceMeter Instrument (200V, 10A Pulse)
2612A	Dual-channel System SourceMeter Instrument (200V, 10A Pulse)
2635A	Single-channel System SourceMeter Instrument (1fA, 10A Pulse)
2636A	Dual-channel System SourceMeter Instrument (1fA, 10A Pulse)

### Accessories Supplied

2600-ALG-2	Low Noise Triax Cable with Alligator Clips, 2m (6.6 ft.) (two supplied with 2636A, one with 2635A)
2600-IAC	Safety Interlock Adapter Connector (one supplied with 2611A/2612A and 2635A/2636A)
2600-Kit	Mating Screw Terminal Connectors with strain relief and covers (2601A/2602A/2611A/2612A)
CA-180-3A	TSP-Link/Ethernet Cable (two per unit)
	TSP Express Software Tool (embedded)
	Test Script Builder Software (supplied on CD)
	ACS Basic Edition Software (optional)

optoelectronic component or ensure that the same stress times are applied to the different pins of an advanced semiconductor device, providing precision timing and synchronization between SMU channels (and external instruments) has become a critical requirement.

A high performance trigger model that is hardware driven allows timing at each source-measure step to be tightly controlled. It also synchronizes the operations between SMU channels and/or external instrumentation at hardware speeds of <500ns.

### Third-generation SMU Design Ensures Faster Test Times

Based on the proven architecture of earlier Series 2600 instruments, the Series 2600A's new SMU design enhances test speed in several ways. For example, while earlier designs used a parallel current ranging topology, the Series 2600A uses a patented series ranging topology, which provides faster and smoother range changes and outputs that settle more quickly.

The Series 2600A SMU design supports two modes of operation for use with a variety of loads. In normal mode, the SMU provides high bandwidth performance for maximum throughput. In high capacitance (high-C) mode, the SMU uses a slower bandwidth to provide robust performance with higher capacitive loads.

Each Series 2600A SMU channel offers a highly flexible, four-quadrant source coupled with precision voltage and current meters. Each channel can be configured as a:

- Precision power supply
- True current source
- DMM (DCV, DCI, ohms, and power with 5½-digit resolution)
- Electronic load (with sink mode capability)
- V or I pulse generator (Pulse width: 100µs and longer)
- V or I waveform generator

All analog-to-digital (A/D) converters in Series 2600A instruments are both high speed and high precision for maximum flexibility. The two A/D converters per channel (one for I, one for V) can run simultaneously, providing precise source-readback without sacrificing test throughput. These A/D converters offer the versatility of programmable integration rates, allowing you to optimize for either high speed (>20,000 rdgs/s at 0.001 NPLC setting) or for high resolution (up to 24 bits at 10 NPLC setting) measurements.

### Digital I/O Interface

A back panel port on every Series 2600A instrument provides 14 bits of universal digital I/O to link the instrument to a variety of popular component handlers and/or probe stations. These digital I/O lines are compatible with the triggering technology of Keithley's earlier Trigger-Link instruments. These lines simplify integrating Series 2600A instruments into systems that employ other electrical, mechanical, optical, or RF equipment.

### TSP-Link Trigger Lines

The TSP-Link bus supports dedicated trigger lines that provide synchronous operations between multiple Series 2600A instruments (and other TSP instruments, such as Series 3700 DMM/Switch Systems) without the need for additional trigger connections.

### Built-in Contact Check Function

The Contact Check function makes it simple to verify good device-under-test connections quickly and easily before an automated test sequence begins. This eliminates the measurement errors and false product failures associated with contact fatigue, breakage, contamination, loose or broken connections, relay failures, etc.

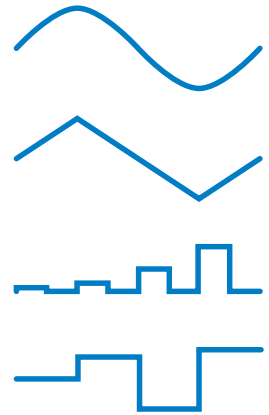

**Current arbitrary waveforms**  
maximum output update rates: 12,500 samples/second.

**Voltage arbitrary waveforms**  
maximum output update rates: 20,000 samples/second.

1.888.KEITHLEY (U.S. only)

[www.keithley.com](http://www.keithley.com)

**KEITHLEY**

A GREATER MEASURE OF CONFIDENCE

# Series 2600A

# System SourceMeter® Instruments

## TYPICAL APPLICATIONS

I-V functional test and characterization of a wide range of devices, including:

- Discrete and passive components
  - Two-leaded – Sensors, disk drive heads, metal oxide varistors (MOVs), diodes, zener diodes, sensors, capacitors, thermistors
  - Three-leaded – Small signal bipolar junction transistors (BJTs), field-effect transistors (FETs), and more
- Simple ICs – Optos, drivers, switches, sensors
- Integrated devices – small scale integrated (SSI) and large scale integrated (LSI)
  - Analog ICs
  - Radio frequency integrated circuits (RFICs)
  - Application specific integrated circuits (ASICs)
  - System on a chip (SOC) devices
- Optoelectronic devices such as light-emitting diodes (LEDs), laser diodes, high brightness LEDs (HBLEDs), vertical cavity surface-emitting lasers (VCSELs), displays
- Wafer level reliability
  - NBTI, TDDB, HCI, electromigration
- Solar Cells
- Batteries

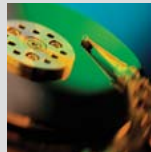
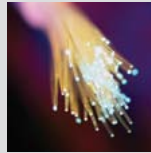

## Powerful Software Tools

In addition to the embedded TSP Express and optional ACS Basic Edition software, the free Test Script Builder software tool is provided to help users create, modify, debug, and store TSP test scripts. Table 1 describes key features of Series 2600A software tools.

## Complete Automated System Solutions

While the ACS Basic Edition software only supports component characterization tests, wafer and cassette level testing can be performed by Keithley's ACS Integrated Test Systems. ACS systems are highly configurable, instrument-based systems that generally include a number of Series 2600A instruments. These systems are designed for semiconductor device characterization, reliability/WLR, parametric, and component functional testing.



The flexible software architecture of ACS Basic Edition allows configuring systems with a wide range of controllers and test fixtures, as well as the exact number of SourceMeter instruments the application requires.



Example ACS Integrated Test System

Table 1. Series 2600A software tools

Feature/Functionality	ACS Basic Edition	TSP Express	Test Script Builder (TSB)
Description	Semiconductor characterization software for component test, verification, and analysis	Quick Start Tool for fast and easy I-V testing, primarily for bench and lab users	Custom script writing tool for TSP instruments
Supported hardware	24xx, 26xx, 26xxA, 4200-SCS, 237	26xxA	26xx, 26xxA, 37xx
Supported buses	GPIB, Ethernet	Ethernet only	GPIB, RS-232, Ethernet
Functionality	Intuitive, wizard-based GUI, Rich set of test libraries	Linear/Log Sweeps, Pulsing, Custom sweeps, Single point source-measures. Note: Uses new 2600A's new API's for precision timing and channel synchronization	Custom scripts with total flexibility
Data management	Formulator tool with wide range of math functions	.csv export, basic curve tracing (no math formula or analysis support)	N/A
Installation	Optional purchase	Not necessary. Embedded in the instrument.	Free Download or CD Install on PC.

Scalable, integrated source and measure solutions

SOURCE AND MEASURE

1.888.KEITHLEY (U.S. only)

www.keithley.com

KEITHLEY

A GREATER MEASURE OF CONFIDENCE

# Series 2600A

# System SourceMeter® Instruments

In the first and third quadrants, Series 2600A instruments operate as a source, delivering power to a load. In the second and fourth quadrants, they operate as a sink, dissipating power internally.

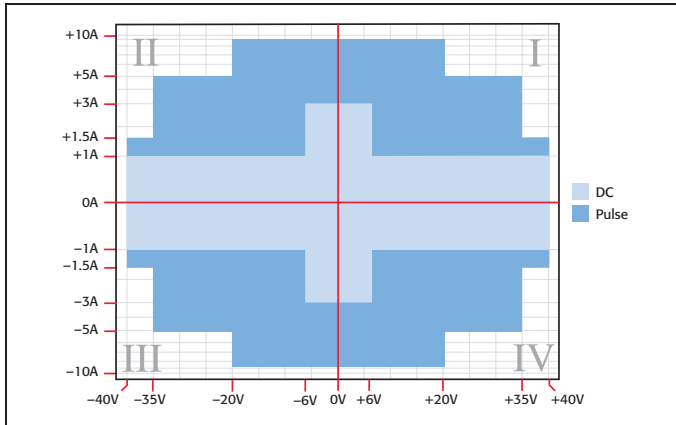

Models 2601A and 2602A I-V capability

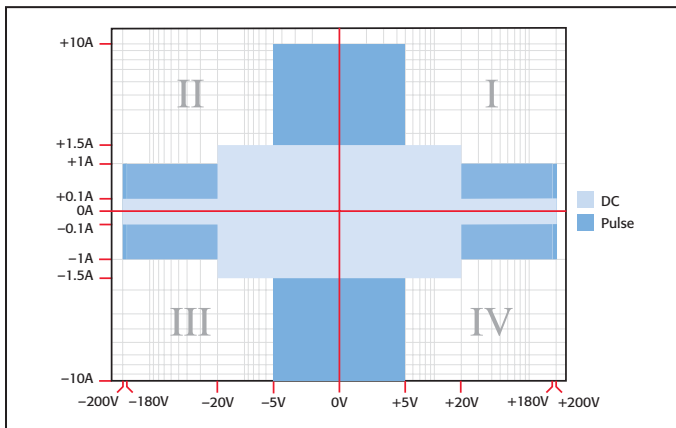

Models 2611A and 2612A I-V capability

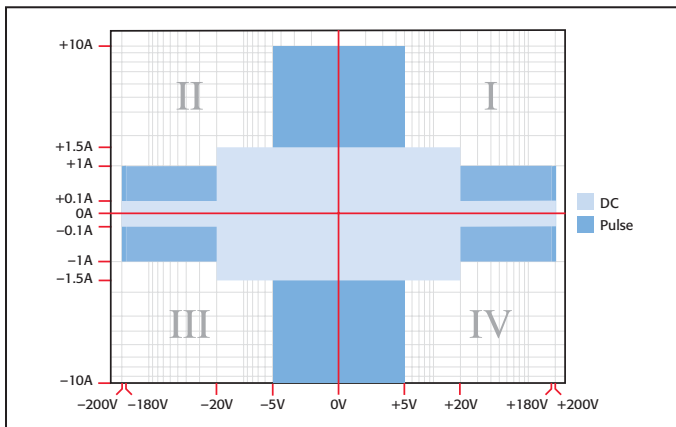

Models 2635A and 2636A I-V capability

## ACCESSORIES AVAILABLE

### CABLES AND CONNECTORS

2600-BAN	Banana Test Leads/Adapter Cable. For a single 2601A/2602A/2611A/2612A SMU channel
2600-KIT	Extra screw terminal connector, strain relief, and cover for a single SourceMeter channel (one supplied with 2601A/2611A, two with 2602A/2612A)
2600-TRIAx	Triax Adapter. For a single 2601A/2602A/2611A/2612A SMU channel
7078-TRX-*	3-Slot, Low Noise Triax Cable. For use with 2600-TRIAx Adapter
7078-TRX-GND	3-Slot male triax to BNC adapter (guard removed)
8606	High Performance Modular Probe Kit. For use with 2600A-BAN
SC-200	Shielded Twisted Pair Cable. Recommended for general-purpose use with Series 2600A System SourceMeter instruments
2600-IAC	Safety Interlock Adapter Connector (one supplied with 2611A/2612A/2635A/2636A)

### DIGITAL I/O, TRIGGER LINK, AND TSP-LINK

2600-TLINK	Digital I/O to TLINK Adapter Cable, 1m
CA-126-1	Digital I/O and Trigger Cable, 1.5m
CA-180-3A	CAT5 Crossover Cable for TSP-Link and direct Ethernet connection (two supplied)

### GPIB INTERFACES AND CABLES

7007-1	Double Shielded GPIB Cable, 1m (3.3 ft.)
7007-2	Double Shielded GPIB Cable, 2m (6.6 ft.)
KPCI-488LPA	IEEE-488 Interface/Controller for the PCI Bus
KPXI-488	IEEE-488 Interface Board for the PXI Bus
KUSB-488B	IEEE-488 USB-to-GPIB Interface Adapter

### SWITCHING

Series 3700	DMM/Switch Systems
707A	Semiconductor Switching Matrix Mainframe
7001	Switch Control Mainframe

### RACK MOUNT KITS

4299-1	Single Rack Mount Kit with front and rear support
4299-2	Dual Rack Mount Kit with front and rear support
4299-5	IU Vent Panel

### SOFTWARE

ACS-BASIC	Component Characterization Software
-----------	-------------------------------------

### EXTENDED WARRANTIES

2601A-EW	1 Year Extended Warranty for Model 2601A
2602A-EW	1 Year Extended Warranty for Model 2602A
2611A-EW	1 Year Extended Warranty for Model 2611A
2612A-EW	1 Year Extended Warranty for Model 2612A
2635A-EW	1 Year Extended Warranty for Model 2635A
2636A-EW	1 Year Extended Warranty for Model 2636A

### CALIBRATION AND VERIFICATION

2600-STD-RES	Calibration Standard 1GΩ Resistor for Models 2635A and 2636A
--------------	--

**Model 2602A/2612A rear panel**  
(Single channels 2601A, 2611A, 2635A not shown)



**Model 2636A rear panel**



Scalable, integrated source and measure solutions

SOURCE AND MEASURE

1.888.KEITHLEY (U.S. only)

[www.keithley.com](http://www.keithley.com)

**KEITHLEY**

A GREATER MEASURE OF CONFIDENCE

# 2601A 2602A

# System SourceMeter® Instruments

## SPECIFICATION CONDITIONS

This document contains specifications and supplemental information for the Models 2601A and 2602A System SourceMeter® instruments. Specifications are the standards against which the Models 2601A and 2602A are tested. Upon leaving the factory, the 2601A and 2602A meet these specifications. Supplemental and typical values are non-warranted, apply at 23°C, and are provided solely as useful information.

Accuracy specifications are applicable for both normal and high capacitance modes. The source and measurement accuracies are specified at the SourceMeter CHANNEL A (2601A and 2602A) or SourceMeter CHANNEL B (2602A) terminals under the following conditions:

1. 23°C ± 5°C, <70% relative humidity
2. After 2 hour warm-up
3. Speed normal (1 NPLC)
4. A/D auto-zero enabled
5. Remote sense operation or properly zeroed local operation
6. Calibration period = 1 year

## SOURCE SPECIFICATIONS

### VOLTAGE SOURCE SPECIFICATIONS

#### VOLTAGE PROGRAMMING ACCURACY<sup>1</sup>

Range	Programming Resolution	Accuracy (1 Year) 23°C ± 5°C ±(% rdg. + volts)	Typical Noise (peak-peak) 0.1Hz–10Hz
100.000 mV	5 μV	0.02% + 250 μV	20 μV
1.00000 V	50 μV	0.02% + 400 μV	50 μV
6.00000 V	50 μV	0.02% + 1.8 mV	100 μV
40.00000 V	500 μV	0.02% + 12 mV	500 μV

TEMPERATURE COEFFICIENT (0°–18°C and 28°–50°C)<sup>2</sup>: ±(0.15 × accuracy specification)/°C. Applicable for normal mode only. Not applicable for high capacitance mode.

MAXIMUM OUTPUT POWER AND SOURCE/SINK LIMITS<sup>3</sup>: 40.4W per channel maximum. ±40.4V @ ±1.0A, ±6.06V @ ±3.0A, four quadrant source or sink operation.

VOLTAGE REGULATION: Line: 0.01% of range. Load: ±(0.01% of range + 100μV).

NOISE 10Hz–20MHz: <20mV peak-peak (typical), <3mV RMS (typical), 6V range.

CURRENT LIMIT/COMPLIANCE<sup>4</sup>: Bipolar current limit (compliance) set with single value. Minimum value is 10nA. Accuracy same as current source.

OVERSHOOT: <±(0.1% + 10mV) typical. Step size = 10% to 90% of range, resistive load, maximum current limit/compliance.

GUARD OFFSET VOLTAGE: <4mV typical. Current <10mA.

### CURRENT SOURCE SPECIFICATIONS

#### CURRENT PROGRAMMING ACCURACY

Range	Programming Resolution	Accuracy (1 Year) 23°C ± 5°C ±(% rdg. + amps)	Typical Noise (peak-peak) 0.1Hz–10Hz
100.000 nA	1 pA	0.06% + 100 pA	5 pA
1.00000 μA	10 pA	0.03% + 800 pA	25 pA
10.0000 μA	100 pA	0.03% + 5 nA	60 pA
100.000 μA	1 nA	0.03% + 60 nA	3 nA
1.00000 mA	10 nA	0.03% + 300 nA	6 nA
10.00000 mA	100 nA	0.03% + 6 μA	200 nA
100.000 mA	1 μA	0.03% + 30 μA	600 nA
1.00000 A <sup>5</sup>	10 μA	0.05% + 1.8 mA	70 μA
3.00000 A <sup>5</sup>	10 μA	0.06% + 4 mA	150 μA
10.0000 A <sup>5,6</sup>	100 μA	0.5 % + 40 mA (typical)	

TEMPERATURE COEFFICIENT (0°–18°C and 28°–50°C)<sup>7</sup>: ±(0.15 × accuracy specification)/°C.

MAXIMUM OUTPUT POWER AND SOURCE/SINK LIMITS<sup>8</sup>: 40.4W per channel maximum. ±1.01A @ ±40.0V, ±3.03A @ ±6.0V, four quadrant source or sink operation.

CURRENT REGULATION: Line: 0.01% of range. Load: ±(0.01% of range + 100pA).

VOLTAGE LIMIT/COMPLIANCE<sup>9</sup>: Bipolar voltage limit (compliance) set with a single value. Minimum value is 10mV. Accuracy is the same as voltage source.

OVERSHOOT: <±0.1% typical (step size = 10% to 90% of range, resistive load; see Current Source Output Settling Time for additional test conditions).

### ADDITIONAL SOURCE SPECIFICATIONS

TRANSIENT RESPONSE TIME: <70μs for the output to recover to within 0.1% for a 10% to 90% step change in load.

VOLTAGE SOURCE OUTPUT SETTLING TIME: Time required to reach within 0.1% of final value after source level command is processed on a fixed range.

100mV, 1V Ranges: <50μs typical.

6V Range: <100μs typical.

40V Range<sup>10</sup>: <150μs typical.

CURRENT SOURCE OUTPUT SETTLING TIME: Time required to reach within 0.1% of final value after source level command is processed on a fixed range. Values below for I<sub>out</sub> × R<sub>load</sub> = 1V unless noted.

3A Range: <80μs typical (current less than 2.5A, R<sub>load</sub> >2Ω).

1A–10mA Ranges: <80μs typical (R<sub>load</sub> >6Ω).

1mA Range: <100μs typical.

100μA Range: <150μs typical.

10μA Range: <500μs typical.

1μA Range: <2.5ms typical.

100nA Range: <25ms typical.

DC FLOATING VOLTAGE: Output can be floated up to ±250VDC from chassis ground.

REMOTE SENSE OPERATING RANGE<sup>11</sup>:

Maximum voltage between HI and SENSE HI = 3V.

Maximum voltage between LO and SENSE LO = 3V.

VOLTAGE OUTPUT HEADROOM:

40V Range: Max. output voltage = 42V – total voltage drop across source leads (maximum 1Ω per source lead).

6V Range: Max. output voltage = 8V – total voltage drop across source leads (maximum 1Ω per source lead).

OVER TEMPERATURE PROTECTION: Internally sensed temperature overload puts unit in standby mode.

VOLTAGE SOURCE RANGE CHANGE OVERSHOOT: <300mV + 0.1% of larger range (typical). Overshoot into an 100kΩ load, 20MHz BW.

CURRENT SOURCE RANGE CHANGE OVERSHOOT: <5% of larger range + 300mV/R<sub>load</sub> (typical with source settling set to SETTLE\_SMOOTH\_100NA). See Current Source Output Settling Time for additional test conditions.

### NOTES

1. Add 50μV to source accuracy specifications per volt of HI lead drop.
2. High Capacitance Mode accuracy is applicable at 23°C ± 5°C only.
3. Full power source operation regardless of load to 30°C ambient. Above 30°C and/or power sink operation, refer to "Operating Boundaries" in the Series 2600A Reference Manual for additional power derating information.
4. For sink mode operation (quadrants II and IV), add 0.06% of limit range to the corresponding current limit accuracy specifications. Specifications apply with sink mode operation enabled.
5. Full power source operation regardless of load to 30°C ambient. Above 30°C and/or power sink operation, refer to "Operating Boundaries" in the Series 2600A Reference Manual for additional power derating information.
6. 10A range accessible only in pulse mode.
7. High Capacitance Mode accuracy is applicable at 23°C ± 5°C only.
8. Full power source operation regardless of load to 30°C ambient. Above 30°C and/or power sink operation, refer to "Operating Boundaries" in the Series 2600A Reference Manual for additional power derating information.
9. For sink mode operation (quadrants II and IV), add 10% of compliance range and ±0.02% of limit setting to corresponding voltage source specification. For 100mV range add an additional 60mV of uncertainty.
10. Add 150μs when measuring on the 1A range.
11. Add 50μV to source accuracy specifications per volt of HI lead drop.

1.888.KEITHLEY (U.S. only)

www.keithley.com

KEITHLEY

# 2601A 2602A

# System SourceMeter® Instruments

Series 2600A specifications

SOURCE AND MEASURE

## SOURCE SPECIFICATIONS (continued)

### PULSE SPECIFICATIONS

Region	Maximum Current Limit	Maximum Pulse Width <sup>12</sup>	Maximum Duty Cycle <sup>13</sup>
1	1 A @ 40 V	DC, no limit	100%
1	3 A @ 6 V	DC, no limit	100%
2	1.5 A @ 40 V	100 ms	25%
3	5 A @ 35 V	4 ms	4%
4	10 A @ 20 V	1.8 ms	1%

MINIMUM PROGRAMMABLE PULSE WIDTH<sup>14, 15</sup>: 100 $\mu$ s. NOTE: Minimum pulse width for settled source at a given I/V output and load can be longer than 100 $\mu$ s.

PULSE WIDTH PROGRAMMING RESOLUTION: 1 $\mu$ s.

PULSE WIDTH PROGRAMMING ACCURACY<sup>15</sup>:  $\pm 5\mu$ s.

PULSE WIDTH JITTER: 2 $\mu$ s (typical).

QUADRANT DIAGRAM:

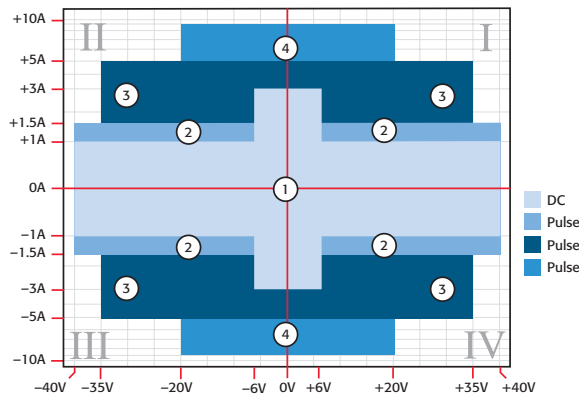

### NOTES

12. Times measured from the start of pulse to the start off-time; see figure below.

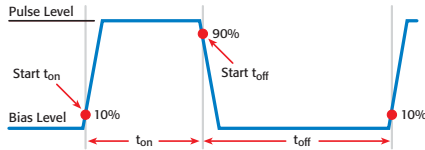

13. Thermally limited in sink mode (quadrants II and IV) and ambient temperatures above 30°C. See power equations in the reference manual for more information.

14. Typical performance for minimum settled pulse widths:

Source Value	Load	Source Settling (% of range)	Min. Pulse Width
6 V	2 $\Omega$	0.2%	150 $\mu$ s
20 V	2 $\Omega$	1%	200 $\mu$ s
35 V	7 $\Omega$	0.5%	500 $\mu$ s
40 V	27 $\Omega$	0.1%	400 $\mu$ s
1.5 A	27 $\Omega$	0.1%	1.5 ms
3 A	2 $\Omega$	0.2%	150 $\mu$ s
5 A	7 $\Omega$	0.5%	500 $\mu$ s
10 A	2 $\Omega$	0.5%	200 $\mu$ s

Typical tests were performed using remote operation, 4W sense, and best, fixed measurement range. For more information on pulse scripts, see the Series 2600A Reference Manual.

15. Times measured from the start of pulse to the start off-time; see figure below.

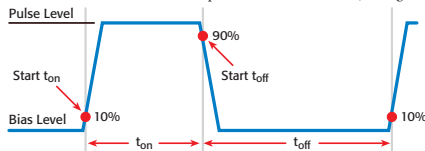

1.888.KEITHLEY (U.S. only)

www.keithley.com

## METER SPECIFICATIONS

### VOLTAGE MEASUREMENT ACCURACY<sup>16, 17</sup>

Range	Display Resolution <sup>18</sup>	Input Resistance	Accuracy (1 Year) 23°C $\pm 5^\circ$ C $\pm$ (% rdg. + volts)
100.000 mV	1 $\mu$ V	>10 G $\Omega$	0.015% + 150 $\mu$ V
1.00000 V	10 $\mu$ V	>10 G $\Omega$	0.015% + 200 $\mu$ V
6.00000 V	10 $\mu$ V	>10 G $\Omega$	0.015% + 1 mV
40.0000 V	100 $\mu$ V	>10 G $\Omega$	0.015% + 8 mV

TEMPERATURE COEFFICIENT (0°–18°C and 28°–50°C)<sup>19</sup>:  $\pm(0.15 \times \text{accuracy specification})/^\circ\text{C}$ . Applicable for normal mode only. Not applicable for high capacitance mode.

### CURRENT MEASUREMENT ACCURACY<sup>17</sup>

Range	Display Resolution <sup>20</sup>	Voltage Burden <sup>21</sup>	Accuracy (1 Year) 23°C $\pm 5^\circ$ C $\pm$ (% rdg. + amps)
100.000 nA	1 pA	<1 mV	0.05% + 100 pA
1.00000 $\mu$ A	10 pA	<1 mV	0.025% + 500 pA
10.0000 $\mu$ A	100 pA	<1 mV	0.025% + 1.5 nA
100.000 $\mu$ A	1 nA	<1 mV	0.02% + 25 nA
1.00000 mA	10 nA	<1 mV	0.02% + 200 nA
10.0000 mA	100 nA	<1 mV	0.02% + 2.5 $\mu$ A
100.000 mA	1 $\mu$ A	<1 mV	0.02% + 20 $\mu$ A
1.00000 A	10 $\mu$ A	<1 mV	0.03% + 1.5 mA
3.00000 A	10 $\mu$ A	<1 mV	0.05% + 3.5 mA
10.0000 A <sup>22</sup>	100 $\mu$ A	<1 mV	0.4% + 25 mA (typical)

CURRENT MEASURE SETTLING TIME (Time for measurement to settle after a  $V_{\text{step}}$ )<sup>23</sup>: Time required to reach within 0.1% of final value after source level command is processed on a fixed range. Values for  $V_{\text{out}} = 1\text{V}$  unless noted. Current Range: 1mA. Settling Time: <100 $\mu$ s (typical).

TEMPERATURE COEFFICIENT (0°–18°C and 28°–50°C)<sup>24</sup>:  $\pm(0.15 \times \text{accuracy specification})/^\circ\text{C}$ . Applicable for normal mode only. Not applicable for high capacitance mode.

### CONTACT CHECK<sup>25</sup>

Speed	Maximum Measurement Time To Memory For 60Hz (50Hz)	Accuracy (1 Year) 23°C $\pm 5^\circ$ C $\pm$ (%rdg. + ohms)
FAST	1 (1.2) ms	5% + 10 $\Omega$
MEDIUM	4 (5) ms	5% + 1 $\Omega$
SLOW	36 (42) ms	5% + 0.3 $\Omega$

### ADDITIONAL METER SPECIFICATIONS

MAXIMUM LOAD IMPEDANCE:

Normal Mode: 10nF (typical). High Capacitance Mode: 50 $\mu$ F (typical).

COMMON MODE VOLTAGE: 250VDC.

COMMON MODE ISOLATION: >1G $\Omega$ , <4500pF.

OVERRANGE: 101% of source range, 102% of measure range.

MAXIMUM SENSE LEAD RESISTANCE: 1k $\Omega$  for rated accuracy.

SENSE INPUT IMPEDANCE: >10G $\Omega$ .

### NOTES

16. Add 50 $\mu$ V to source accuracy specifications per volt of HI lead drop.

17. De-rate accuracy specifications for NPLC setting < 1 by increasing error term.

Add appropriate % of range term using table below.

NPLC Setting	100mV Range	1V–40V Ranges	100nA Range	1 $\mu$ A–100mA Ranges	1A–3A Ranges
0.1	0.01%	0.01%	0.01%	0.01%	0.01%
0.01	0.08%	0.07%	0.1%	0.05%	0.05%
0.001	0.8 %	0.6 %	1%	0.5 %	1.1 %

18. Applies when in single channel display mode.

19. High Capacitance Mode accuracy is applicable for 23°C  $\pm 5^\circ$ C only.

20. Applies when in single channel display mode.

21. Four-wire remote sense only with current meter mode selected. Voltage measure set to 100mV or 1V range only.

22. 10A range accessible only in pulse mode.

23. Compliance equal to 100mA.

24. High Capacitance Mode accuracy is applicable for 23°C  $\pm 5^\circ$ C only.

25. Includes measurement of SENSE HI to HI and SENSE LO to LO contact resistances.

KEITHLEY

# 2601A 2602A

# System SourceMeter® Instruments

## HIGH CAPACITANCE MODE<sup>26, 27, 28</sup>

**VOLTAGE SOURCE OUTPUT SETTLING TIME:** Time required to reach 0.1% of final value after source level command is processed on a fixed range. Current limit = 1A.

Voltage Source Range	Settling Time with $C_{load} = 4.7\mu F$
100 mV	200 $\mu s$ (typical)
1 V	200 $\mu s$ (typical)
6 V	200 $\mu s$ (typical)
40 V	7 ms (typical)

**CURRENT MEASURE SETTLING TIME:** Time required to reach 0.1% of final value after voltage source is stabilized on a fixed range. Values below for  $V_{out} = 1V$  unless noted.

Current Measure Range	Settling Time
3 A – 1 A	<120 $\mu s$ (typical) ( $R_{load} > 2\Omega$ )
100 mA – 10 mA	<100 $\mu s$ (typical)
1 mA	< 3 ms (typical)
100 $\mu A$	< 3 ms (typical)
10 $\mu A$	< 230 ms (typical)
1 $\mu A$	< 230 ms (typical)

**CAPACITOR LEAKAGE PERFORMANCE USING HIGH-C SCRIPTS<sup>29</sup>:** Load =  $5\mu F || 10M\Omega$ .  
Test: 5V step and measure. 200ms (typical) @ 50nA.

### MODE CHANGE DELAY:

- 100 $\mu A$  Current Range and Above:**
  - Delay into High Capacitance Mode: 10ms.
  - Delay out of High Capacitance Mode: 10ms.
- 1 $\mu A$  and 10 $\mu A$  Current Ranges:**
  - Delay into High Capacitance Mode: 230ms.
  - Delay out of High Capacitance Mode: 10ms.

**VOLTMETER INPUT IMPEDANCE:** 10G $\Omega$  in parallel with 3300pF.

**NOISE, 10Hz–20MHz (6V Range):** <30mV peak-peak (typical).

**VOLTAGE SOURCE RANGE CHANGE OVERSHOOT:** <400mV + 0.1% of larger range (typical).  
Overshoot into a 100k $\Omega$  load, 20MHz BW.

### NOTES

- High Capacitance Mode specifications are for DC measurements only.
- 100nA range is not available in High Capacitance Mode.
- High Capacitance Mode utilizes locked ranges. Auto Range is disabled.
- Part of KI Factory scripts. See reference manual for details.

## GENERAL

**IEEE-488:** IEEE-488.1 compliant. Supports IEEE-488.2 common commands and status model topology.

**RS-232:** Baud rates from 300bps to 115200bps. Programmable number of data bits, parity type, and flow control (RTS/CTS hardware or none). When not programmed as the active host interface, the SourceMeter instrument can use the RS-232 interface to control other instrumentation.

**ETHERNET:** RJ-45 connector, LXI Class C, 10/100BT, no auto MDIX.

**EXPANSION INTERFACE:** The TSP-Link expansion interface allows TSP enabled instruments to trigger and communicate with each other.

**Cable Type:** Category 5e or higher LAN crossover cable.

**Length:** 3 meters maximum between each TSP enabled instrument.

**LXI COMPLIANCE:** LXI Class C 1.2.

**LXI TIMING:** Total Output Trigger Response Time: 245 $\mu s$  min., 280 $\mu s$  typ., (not specified) max. Receive LAN[0-7] Event Delay: Unknown. Generate LAN[0-7] Event Delay: Unknown.

### DIGITAL I/O INTERFACE:

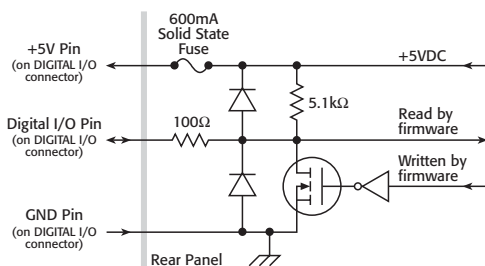

**Connector:** 25-pin female D.

**Input/Output Pins:** 14 open drain I/O bits.

**Absolute Maximum Input Voltage:** 5.25V.

**Absolute Minimum Input Voltage:** -0.25V.

**Maximum Logic Low Input Voltage:** 0.7V, +850 $\mu A$  max.

**Minimum Logic High Input Voltage:** 2.1V, +570 $\mu A$ .

**Maximum Source Current (flowing out of Digital I/O bit):** +960 $\mu A$ .

**Maximum Sink Current @ Maximum Logic Low Voltage (0.7V):** -5.0mA.

**Absolute Maximum Sink Current (flowing into Digital I/O pin):** -11mA.

**5V Power Supply Pin:** Limited to 600mA, solid state fuse protected.

**Safety Interlock Pin:** Active high input. >3.4V @ 24mA (absolute maximum of 6V) must be externally applied to this pin to ensure 200V operation. This signal is pulled down to chassis ground with a 10k $\Omega$  resistor. 200V operation will be blocked when the INTERLOCK signal is <0.4V (absolute minimum -0.4V). See figure below:

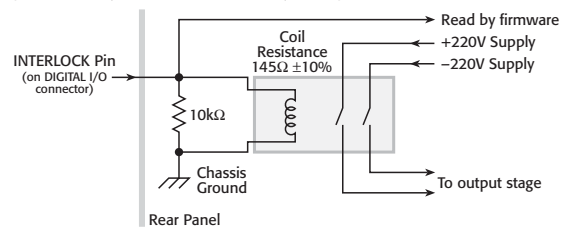

**USB:** USB 1.0 Host Controller (Memory Stick I/O).

**POWER SUPPLY:** 100V to 250VAC, 50–60Hz (auto sensing), 240VA max.

**COOLING:** Forced air. Side intake and rear exhaust. One side must be unobstructed when rack mounted.

**EMC:** Conforms to European Union Directive 2004/108/EEC, EN 61326-1.

**SAFETY:** Conforms to European Union Directive 73/23/EEC, EN 61010-1, and UL 61010-1.

**DIMENSIONS:** 89mm high × 213mm wide × 460mm deep (3½ in × 8½ in × 17½ in). Bench Configuration (with handle and feet): 104mm high × 238mm wide × 460mm deep (4½ in × 9½ in × 17½ in).

**WEIGHT:** 2601A: 4.75kg (10.4 lbs). 2602A: 5.50kg (12.0 lbs).

**ENVIRONMENT:** For indoor use only.

**Altitude:** Maximum 2000 meters above sea level.

**Operating:** 0°–50°C, 70% R.H. up to 35°C. Derate 3% R.H./°C, 35°–50°C.

**Storage:** -25°C to 65°C.

SEE PAGES 24 AND 25 FOR MEASUREMENT SPEEDS AND OTHER SPECIFICATIONS.

1.888.KEITHLEY (U.S. only)

www.keithley.com

KEITHLEY

A GREATER MEASURE OF CONFIDENCE



# 2611A 2612A

# System SourceMeter® Instruments

Series 2600A specifications

SOURCE AND MEASURE

## SPECIFICATION CONDITIONS

This document contains specifications and supplemental information for the Models 2611A and 2612A System SourceMeter® instruments. Specifications are the standards against which the Models 2611A and 2612A are tested. Upon leaving the factory the 2611A and 2612A meet these specifications. Supplemental and typical values are non-warranted, apply at 23°C, and are provided solely as useful information.

Accuracy specifications are applicable for both normal and high capacitance modes. The source and measurement accuracies are specified at the SourceMeter CHANNEL A (2611A and 2612A) or SourceMeter CHANNEL B (2612A) terminals under the following conditions:

- 23°C ± 5°C, <70% relative humidity.
- After 2 hour warm-up.
- Speed normal (1 NPLC).
- A/D auto-zero enabled.
- Remote sense operation or properly zeroed local sense operation.
- Calibration period = 1 year.

## SOURCE SPECIFICATIONS

### VOLTAGE SOURCE SPECIFICATIONS

#### VOLTAGE PROGRAMMING ACCURACY<sup>1</sup>

Range	Programming Resolution	Accuracy (1 Year) 23°C ± 5°C ±(% rdg. + volts)	Typical Noise (Peak-Peak) 0.1Hz–10Hz
200.000 mV	5 μV	0.02% + 375 μV	20 μV
2.00000 V	50 μV	0.02% + 600 μV	50 μV
20.0000 V	500 μV	0.02% + 5 mV	300 μV
200.000 V	5 mV	0.02% + 50 mV	2 mV

**TEMPERATURE COEFFICIENT** (0°–18°C and 28°–50°C)<sup>2</sup>: ±(0.15 × accuracy specification)/°C. Applicable for normal mode only. Not applicable for high capacitance mode.

**MAXIMUM OUTPUT POWER AND SOURCE/SINK LIMITS**<sup>3</sup>: 30.3W per channel maximum. ±20.2V @ ±1.5A, ±202V @ ±100mA, four quadrant source or sink operation.

**VOLTAGE REGULATION**: Line: 0.01% of range. Load: ±(0.01% of range + 100μV).

**NOISE 10Hz–20MHz**: <20mV peak-peak (typical), <3mV RMS (typical), 20V range.

**CURRENT LIMIT/COMPLIANCE**<sup>4</sup>: Bipolar current limit (compliance) set with single value. Minimum value is 10nA. Accuracy is the same as current source.

**OVERSHOOT**: <±(0.1% + 10mV) (typical). Step size = 10% to 90% of range, resistive load, maximum current limit/compliance.

**GUARD OFFSET VOLTAGE**: <4mV (current <10mA).

### CURRENT SOURCE SPECIFICATIONS

#### CURRENT PROGRAMMING ACCURACY<sup>5</sup>

Range	Programming Resolution	Accuracy (1 Year) 23°C ± 5°C ±(% rdg. + amps)	Typical Noise (Peak-Peak) 0.1Hz–10Hz
100.000 nA	2 pA	0.06% + 100 pA	5 pA
1.00000 μA	20 pA	0.03% + 800 pA	25 pA
10.0000 μA	200 pA	0.03% + 5 nA	60 pA
100.000 μA	2 nA	0.03% + 60 nA	3 nA
1.00000 mA	20 nA	0.03% + 300 nA	6 nA
10.0000 mA	200 nA	0.03% + 6 μA	200 nA
100.000 mA	2 μA	0.03% + 30 μA	600 nA
1.00000 A <sup>6</sup>	20 μA	0.05% + 1.8 mA	70 μA
1.50000 A <sup>6</sup>	50 μA	0.06% + 4 mA	150 μA
10.0000 A <sup>6,7</sup>	200 μA	0.5% + 40 mA (typical)	

**TEMPERATURE COEFFICIENT** (0°–18°C and 28°–50°C)<sup>8</sup>: ±(0.15 × accuracy specification)/°C. Applicable for normal mode only. Not applicable for high capacitance mode.

**MAXIMUM OUTPUT POWER AND SOURCE/SINK LIMITS**<sup>3</sup>: 30.3W per channel maximum. ±1.515A @ ±20V, ±101mA @ ±200V, four quadrant source or sink operation.

**CURRENT REGULATION**: Line: 0.01% of range. Load: ±(0.01% of range + 100pA).

**VOLTAGE LIMIT/COMPLIANCE**<sup>9</sup>: Bipolar voltage limit (compliance) set with a single value. Minimum value is 20mV. Accuracy is the same as voltage source.

**OVERSHOOT**: <±0.1% (typical). Step size = 10% to 90% of range, resistive load; see Current Source Output Settling Time for additional test conditions.

## ADDITIONAL SOURCE SPECIFICATIONS

**TRANSIENT RESPONSE TIME**: <70μs for the output to recover to within 0.1% for a 10% to 90% step change in load.

**VOLTAGE SOURCE OUTPUT SETTLING TIME**: Time required to within reach 0.1% of final value after source level command is processed on a fixed range.

Range	Settling Time
200 mV	<50 μs (typical)
2 V	<50 μs (typical)
20 V	<110 μs (typical)
200 V	<700 μs (typical)

**CURRENT SOURCE OUTPUT SETTLING TIME**: Time required to reach within 0.1% of final value after source level command is processed on a fixed range. Values below for I<sub>out</sub> · R<sub>load</sub> = 2V unless noted.

Current Range	Settling Time
1.5 A – 1 A	<120 μs (typical) (R <sub>load</sub> > 6Ω)
100 mA – 10 mA	<80 μs (typical)
1 mA	<100 μs (typical)
100 μA	<150 μs (typical)
10 μA	<500 μs (typical)
1 μA	<2 ms (typical)
100 nA	<20 ms (typical)

**DC FLOATING VOLTAGE**: Output can be floated up to ±250VDC from chassis ground.

**REMOTE SENSE OPERATING RANGE**<sup>11</sup>: Maximum voltage between HI and SENSE HI = 3V. Maximum voltage between LO and SENSE LO = 3V.

**VOLTAGE OUTPUT HEADROOM**:

**200V Range**: Max. output voltage = 202.3V – total voltage drop across source leads (maximum 1Ω per source lead).

**20V Range**: Max. output voltage = 23.3V – total voltage drop across source leads (maximum 1Ω per source lead).

**OVER TEMPERATURE PROTECTION**: Internally sensed temperature overload puts unit in standby mode.

**VOLTAGE SOURCE RANGE CHANGE OVERSHOOT**: <300mV + 0.1% of larger range (typical). Overshoot into a 200kΩ load, 20MHz BW.

**CURRENT SOURCE RANGE CHANGE OVERSHOOT**: <5% of larger range + 300mV/R<sub>load</sub> (typical – With source settling set to SETTLE\_SMOOTH\_100NA). See Current Source Output Settling Time for additional test conditions.

## NOTES

- Add 50μV to source accuracy specifications per volt of HI lead drop.
- High Capacitance Mode accuracy is applicable at 23°C ± 5°C only.
- Full power source operation regardless of load to 30°C ambient. Above 30°C and/or power sink operation, refer to “Operating Boundaries” in the Series 2600A Reference Manual for additional power derating information.
- For sink mode operation (quadrants II and IV), add 0.06% of limit range to the corresponding current limit accuracy specifications. Specifications apply with sink mode operation enabled.
- Accuracy specifications do not include connector leakage. Derate accuracy by V<sub>out</sub>/2E11 per °C when operating between 18°–28°C. Derate accuracy by V<sub>out</sub>/2E11 + (0.15V<sub>out</sub>/2E11) per °C when operating <18°C and >28°C.
- Full power source operation regardless of load to 30°C ambient. Above 30°C and/or power sink operation, refer to “Operating Boundaries” in the Series 2600A Reference Manual for additional power derating information.
- 10A range accessible only in pulse mode.
- High Capacitance Mode accuracy is applicable at 23°C ± 5°C only.
- Full power source operation regardless of load to 30°C ambient. Above 30°C and/or power sink operation, refer to “Operating Boundaries” in the Series 2600A Reference Manual for additional power derating information.
- For sink mode operation (quadrants II and IV), add 10% of compliance range and ±0.02% of limit setting to corresponding voltage source specification. For 200mV range add an additional 120mV of uncertainty.
- Add 50μV to source accuracy specifications per volt of HI lead drop.

## PULSE SPECIFICATIONS

Region	Maximum Current Limit	Maximum Pulse Width <sup>12</sup>	Maximum Duty Cycle <sup>13</sup>
1	100 mA @ 200 V	DC, no limit	100%
1	1.5 A @ 20 V	DC, no limit	100%
2	1 A @ 180 V	8.5 ms	1%
3 <sup>14</sup>	1 A @ 200 V	2.2 ms	1%
4	10 A @ 5 V	1 ms	2.2%

**MINIMUM PROGRAMMABLE PULSE WIDTH**<sup>15, 16</sup>: 100μs. NOTE: Minimum pulse width for settled source at a given I/V output and load can be longer than 100μs.

**PULSE WIDTH PROGRAMMING RESOLUTION**: 1μs.

**PULSE WIDTH PROGRAMMING ACCURACY**<sup>16</sup>: ±5μs.

**PULSE WIDTH JITTER**: 2μs (typical).

1.888.KEITHLEY (U.S. only)

www.keithley.com

KEITHLEY

A GREATER MEASURE OF CONFIDENCE

# 2611A 2612A

# System SourceMeter® Instruments

## SOURCE SPECIFICATIONS (continued)

### PULSE SPECIFICATIONS (continued)

QUADRANT DIAGRAM:

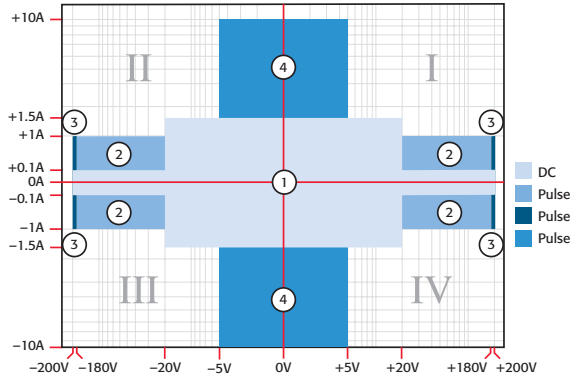

### NOTES

12. Times measured from the start of pulse to the start off-time; see figure below.

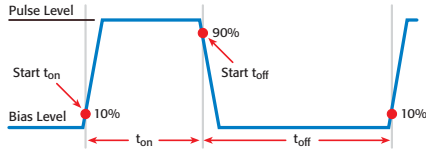

13. Thermally limited in sink mode (quadrants II and IV) and ambient temperatures above 30°C. See power equations in the reference manual for more information.

14. Voltage source operation with 1.5 A current limit.

15. Typical performance for minimum settled pulse widths:

Source Value	Load	Source Settling (% of range)	Min. Pulse Width
5 V	0.5 Ω	1%	300 μs
20 V	200 Ω	0.2%	200 μs
180 V	180 Ω	0.2%	5 ms
200 V (1.5 A Limit)	200 Ω	0.2%	1.5 ms
100 mA	200 Ω	1%	200 μs
1 A	200 Ω	1%	500 μs
1 A	180 Ω	0.2%	5 ms
10 A	0.5 Ω	0.5%	300 μs

Typical tests were performed using remote operation, 4W sense, and best, fixed measurement range. For more information on pulse scripts, see the Series 2600A Reference Manual.

16. Times measured from the start of pulse to the start off-time; see figure below.

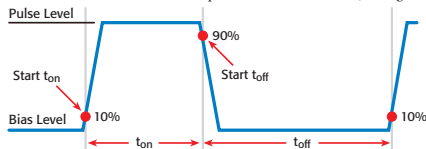

## METER SPECIFICATIONS

### VOLTAGE MEASUREMENT ACCURACY<sup>17, 18</sup>

Range	Display Resolution <sup>19</sup>	Input Resistance	Accuracy (1 Year) 23°C ±5°C ±(% rdg. + volts)
200.000 mV	1 μV	>10 GΩ	0.015% + 225 μV
2.00000 V	10 μV	>10 GΩ	0.02% + 350 μV
20.0000 V	100 μV	>10 GΩ	0.015% + 5 mV
200.000 V	1 mV	>10 GΩ	0.015% + 50 mV

TEMPERATURE COEFFICIENT (0°–18°C and 28°–50°C)<sup>20</sup>: ±(0.15 × accuracy specification)/°C. Applicable for normal mode only. Not applicable for high capacitance mode.

### CURRENT MEASUREMENT ACCURACY<sup>18, 21</sup>

Range	Display Resolution <sup>22</sup>	Voltage Burden <sup>23</sup>	Accuracy (1 Year) 23°C ±5°C ±(% rdg. + amps)
100.000 nA	1 pA	<1 mV	0.06% + 100 pA
1.00000 μA	10 pA	<1 mV	0.025% + 500 pA
10.0000 μA	100 pA	<1 mV	0.025% + 1.5 nA
100.000 μA	1 nA	<1 mV	0.02% + 25 nA
1.00000 mA	10 nA	<1 mV	0.02% + 200 nA
10.0000 mA	100 nA	<1 mV	0.02% + 2.5 μA
100.000 mA	1 μA	<1 mV	0.02% + 20 μA
1.00000 A	10 μA	<1 mV	0.03% + 1.5 mA
1.50000 A	10 μA	<1 mV	0.05% + 3.5 mA
10.0000 A <sup>24</sup>	100 μA	<1 mV	0.4% + 25 mA (typical)

CURRENT MEASURE SETTLING TIME (Time for measurement to settle after a Vstep)<sup>25</sup>: Time required to reach 0.1% of final value after source level command is processed on a fixed range. Values for V<sub>out</sub> = 2V unless noted. Current Range: 1mA. Settling Time: <100μs (typical).

TEMPERATURE COEFFICIENT (0°–18°C and 28°–50°C)<sup>26</sup>: ±(0.15 × accuracy specification)/°C. Applicable for normal mode only. Not applicable for high capacitance mode.

### CONTACT CHECK<sup>27</sup>

Speed	Maximum Measurement Time to Memory For 60Hz (50Hz)	Accuracy (1 Year) 23°C ±5°C ±(%rdg. + ohms)
FAST	1 (1.2) ms	5% + 10 Ω
MEDIUM	4 (5) ms	5% + 1 Ω
SLOW	36 (42) ms	5% + 0.3 Ω

## ADDITIONAL METER SPECIFICATIONS

MAXIMUM LOAD IMPEDANCE:

Normal Mode: 10nF (typical). High Capacitance Mode: 50μF (typical).

COMMON MODE VOLTAGE: 250VDC.

COMMON MODE ISOLATION: >1GΩ, <4500pF.

OVERRANGE: 101% of source range, 102% of measure range.

MAXIMUM SENSE LEAD RESISTANCE: 1kΩ for rated accuracy.

SENSE INPUT IMPEDANCE: >10GΩ.

1.888.KEITHLEY (U.S. only)

www.keithley.com

KEITHLEY

# 2611A 2612A

# System SourceMeter® Instruments

Series 2600A specifications

SOURCE AND MEASURE

## METER SPECIFICATIONS (continued)

### NOTES

- Add 50µV to source accuracy specifications per volt of HI lead drop.
- De-rate accuracy specifications for NPLC setting <1 by increasing error term. Add appropriate % of range term using table below.

NPLC Setting	200mV Range	2V–200V Ranges	100nA Range	1µA–100mA Ranges	1A–1.5A Ranges
0.1	0.01%	0.01%	0.01%	0.01%	0.01%
0.01	0.08%	0.07%	0.1%	0.05%	0.05%
0.001	0.8 %	0.6 %	1%	0.5 %	1.1 %

- Applies when in single channel display mode.
- High Capacitance Mode accuracy is applicable at 23°C ±5°C only.
- Accuracy specifications do not include connector leakage. De-rate accuracy by  $V_{out}/2E11$  per °C when operating between 18°–28°C. De-rate accuracy by  $V_{out}/2E11 + (0.15 * V_{out}/2E11)$  per °C when operating <18° and >28°C.
- Applies when in single channel display mode.
- Four-wire remote sense only and with current meter mode selected. Voltage measure set to 200mV or 2V range only.
- 10A range accessible only in pulse mode.
- Compliance equal to 100mA.
- High Capacitance Mode accuracy is applicable at 23°C ±5°C only.
- Includes measurement of SENSE HI to HI and SENSE LO to LO contact resistances.

## HIGH CAPACITANCE MODE 28, 29, 30

**VOLTAGE SOURCE OUTPUT SETTLING TIME:** Time required to reach within 0.1% of final value after source level command is processed on a fixed range. Current limit = 1A.

Voltage Source Range	Settling Time with $C_{load} = 4.7\mu F$
200 mV	600 µs (typical)
2 V	600 µs (typical)
20 V	1.5 ms (typical)
200 V	20 ms (typical)

**CURRENT MEASURE SETTLING TIME:** Time required to reach within 0.1% of final value after voltage source is stabilized on a fixed range. Values below for  $V_{out} = 2V$  unless noted.

Current Measure Range	Settling Time
1.5 A – 1 A	<120 µs (typical) ( $R_{load} > 6\Omega$ )
100 mA – 10 mA	<100 µs (typical)
1 mA	< 3 ms (typical)
100 µA	< 3 ms (typical)
10 µA	< 230 ms (typical)
1 µA	< 230 ms (typical)

**CAPACITOR LEAKAGE PERFORMANCE USING HIGH-C SCRIPTS**<sup>31</sup>: Load = 5µF || 10MΩ.

Test: 5V step and measure. 200ms (typical) @ 50nA.

### MODE CHANGE DELAY:

- 100µA Current Range and Above:**  
 Delay into High Capacitance Mode: 10ms.  
 Delay out of High Capacitance Mode: 10ms.
- 1µA and 10µA Current Ranges:**  
 Delay into High Capacitance Mode: 230ms.  
 Delay out of High Capacitance Mode: 10ms.

**VOLTMETER INPUT IMPEDANCE:** 30GΩ in parallel with 3300pF.

**NOISE, 10Hz–20MHz (20V Range):** <30mV peak-peak (typical).

**VOLTAGE SOURCE RANGE CHANGE OVERSHOOT (for 20V range and below):** <400mV + 0.1% of larger range (typical). Overshoot into a 200kΩ load, 20MHz BW.

### NOTES

- High Capacitance Mode specifications are for DC measurements only.
- 100nA range is not available in High Capacitance Mode.
- High Capacitance Mode utilizes locked ranges. Auto Range is disabled.
- Part of KI Factory scripts, See reference manual for details.

**SEE PAGES 24 AND 25 FOR MEASUREMENT SPEEDS AND OTHER SPECIFICATIONS.**

## GENERAL

**IEEE-488:** IEEE-488.1 compliant. Supports IEEE-488.2 common commands and status model topology.

**RS-232:** Baud rates from 300bps to 115200bps. Programmable number of data bits, parity type, and flow control (RTS/CTS hardware or none). When not programmed as the active host interface, the SourceMeter instrument can use the RS-232 interface to control other instrumentation.

**ETHERNET:** RJ-45 connector, LXI Class C, 10/100BT, no auto MDIX.

**EXPANSION INTERFACE:** The TSP-Link expansion interface allows TSP enabled instruments to trigger and communicate with each other.

**Cable Type:** Category 5e or higher LAN crossover cable.

**Length:** 3 meters maximum between each TSP enabled instrument.

**LXI COMPLIANCE:** LXI Class C 1.2.

**LXI TIMING: Total Output Trigger Response Time:** 245µs min., 280µs typ., (not specified) max. **Receive LAN[0-7] Event Delay:** Unknown. **Generate LAN[0-7] Event Delay:** Unknown.

### DIGITAL I/O INTERFACE:

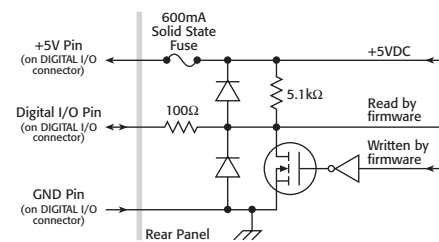

**Connector:** 25-pin female D.

**Input/Output Pins:** 14 open drain I/O bits.

**Absolute Maximum Input Voltage:** 5.25V.

**Absolute Minimum Input Voltage:** –0.25V.

**Maximum Logic Low Input Voltage:** 0.7V, +850µA max.

**Minimum Logic High Input Voltage:** 2.1V, +570µA.

**Maximum Source Current (flowing out of Digital I/O bit):** +960µA.

**Maximum Sink Current @ Maximum Logic Low Voltage (0.7V):** –5.0mA.

**Absolute Maximum Sink Current (flowing into Digital I/O pin):** –11mA.

**5V Power Supply Pin:** Limited to 600mA, solid state fuse protected.

**Safety Interlock Pin:** Active high input. >3.4V @ 24mA (absolute maximum of 6V) must be externally applied to this pin to ensure 200V operation. This signal is pulled down to chassis ground with a 10kΩ resistor. 200V operation will be blocked when the INTERLOCK signal is <0.4V (absolute minimum –0.4V). See figure below:

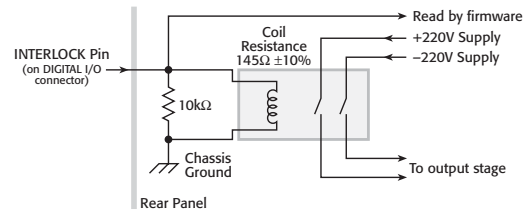

**USB:** USB 1.0 Host Controller (Memory Stick I/O).

**POWER SUPPLY:** 100V to 250VAC, 50–60Hz (auto sensing), 240VA max.

**COOLING:** Forced air. Side intake and rear exhaust. One side must be unobstructed when rack mounted.

**EMC:** Conforms to European Union Directive 2004/108/EEC, EN 61326-1.

**SAFETY:** Conforms to European Union Directive 73/23/EEC, EN 61010-1, and UL 61010-1.

**DIMENSIONS:** 89mm high × 213mm wide × 460mm deep (3½ in × 8½ in × 17½ in). Bench Configuration (with handle and feet): 104mm high × 238mm wide × 460mm deep (4½ in × 9½ in × 17½ in).

**WEIGHT:** 2611A: 4.75kg (10.4 lbs). 2612A: 5.50kg (12.0 lbs).

**ENVIRONMENT:** For indoor use only. **Altitude:** Maximum 2000 meters above sea level.

**Operating:** 0°–50°C, 70% R.H. up to 35°C. Derate 3% R.H./°C, 35°–50°C.

**Storage:** –25°C to 65°C.

**1.888.KEITHLEY (U.S. only)**

**www.keithley.com**

**KEITHLEY**

A GREATER MEASURE OF CONFIDENCE

# 2635A 2636A

# System SourceMeter® Instruments

## SPECIFICATION CONDITIONS

This document contains specifications and supplemental information for the Models 2635A and 2636A System SourceMeter® instruments. Specifications are the standards against which the Models 2635A and 2636A are tested. Upon leaving the factory the 2635A and 2636A meet these specifications. Supplemental and typical values are non-warranted, apply at 23°C, and are provided solely as useful information.

Accuracy specifications are applicable for both normal and high capacitance modes.

The source and measurement accuracies are specified at the SourceMeter CHANNEL A (2635A and 2636A) or SourceMeter CHANNEL B (2636A) terminals under the following conditions:

1. 23°C ± 5°C, <70% relative humidity.
2. After 2 hour warm-up
3. Speed normal (1 NPLC)
4. A/D auto-zero enabled
5. Remote sense operation or properly zeroed local sense operation
6. Calibration period = 1 year

## SOURCE SPECIFICATIONS

### VOLTAGE SOURCE SPECIFICATIONS

#### VOLTAGE PROGRAMMING ACCURACY<sup>1</sup>

Range	Programming Resolution	Accuracy (1 Year) 23°C ± 5°C ±(% rdg. + volts)	Typical Noise (peak-peak) 0.1Hz–10Hz
200.000 mV	5 µV	0.02% + 375 µV	20 µV
2.00000 V	50 µV	0.02% + 600 µV	50 µV
20.0000 V	500 µV	0.02% + 5 mV	300 µV
200.000 V	5 mV	0.02% + 50 mV	2 mV

TEMPERATURE COEFFICIENT (0°–18°C and 28°–50°C)<sup>2</sup>: ±(0.15 × accuracy specification)/°C. Applicable for normal mode only. Not applicable for high capacitance mode.

MAXIMUM OUTPUT POWER AND SOURCE/SINK LIMITS<sup>3</sup>: 30.3W per channel maximum. ±20.2V @ ±1.5A, ±202V @ ±100mA, four quadrant source or sink operation.

VOLTAGE REGULATION: Line: 0.01% of range. Load: ±(0.01% of range + 100µV).

NOISE 10Hz–20MHz: <20mV pk-pk (typical), <3mV rms (typical), 20V range.

CURRENT LIMIT/COMPLIANCE<sup>4</sup>: Bipolar current limit (compliance) set with single value. Minimum value is 100pA. Accuracy is the same as current source.

OVERSHOOT: <±(0.1% + 10mV) typical (step size = 10% to 90% of range, resistive load, maximum current limit/compliance).

GUARD OFFSET VOLTAGE: <4mV (current <10mA).

### CURRENT SOURCE SPECIFICATIONS

#### CURRENT PROGRAMMING ACCURACY

Range	Programming Resolution	Accuracy (1 Year) 23°C ± 5°C ±(% rdg. + amps)	Typical Noise (peak-peak) 0.1Hz–10Hz
1.00000 nA	20 fA	0.15% + 2 pA	800 fA
10.0000 nA	200 fA	0.15% + 5 pA	2 pA
100.000 nA	2 pA	0.06% + 50 pA	5 pA
1.00000 µA	20 pA	0.03% + 700 pA	25 pA
10.0000 µA	200 pA	0.03% + 5 nA	60 pA
100.000 µA	2 nA	0.03% + 60 nA	3 nA
1.00000 mA	20 nA	0.03% + 300 nA	6 nA
10.0000 mA	200 nA	0.03% + 6 µA	200 nA
100.000 mA	2 µA	0.03% + 30 µA	600 nA
1.00000 A <sup>5</sup>	20 µA	0.05% + 1.8 mA	70 µA
1.50000 A <sup>5,6</sup>	50 µA	0.06% + 4 mA	150 µA
10.0000 A <sup>5,6</sup>	200 µA	0.5% + 40 mA (typical)	

TEMPERATURE COEFFICIENT (0°–18°C and 28°–50°C)<sup>7</sup>: ±(0.15 × accuracy specification)/°C. Applicable for normal mode only. Not applicable for high capacitance mode.

MAXIMUM OUTPUT POWER AND SOURCE/SINK LIMITS<sup>8</sup>: 30.3W per channel maximum. ±1.515A @ ±20V, ±101mA @ ±200V, four quadrant source or sink operation.

CURRENT REGULATION: Line: 0.01% of range. Load: ±(0.01% of range + 100pA).

VOLTAGE LIMIT/COMPLIANCE<sup>9</sup>: Bipolar voltage limit (compliance) set with a single value. Minimum value is 20mV. Accuracy is the same as voltage source.

OVERSHOOT: <±0.1% typical (step size = 10% to 90% of range, resistive load, maximum current limit/compliance; see Current Source Output Settling Time for additional test conditions).

### ADDITIONAL SOURCE SPECIFICATIONS

TRANSIENT RESPONSE TIME: <70µs for the output to recover to within 0.1% for a 10% to 90% step change in load.

VOLTAGE SOURCE OUTPUT SETTLING TIME: Time required to reach within 0.1% of final value after source level command is processed on a fixed range.

Range	Settling Time
200 mV	<50 µs (typical)
2 V	<50 µs (typical)
20 V	<110 µs (typical)
200 V	<700 µs (typical)

CURRENT SOURCE OUTPUT SETTLING TIME: Time required to reach within 0.1% of final value after source level command is processed on a fixed range. Values below for I<sub>out</sub> · R<sub>load</sub> = 2V unless noted.

Current Range	Settling Time
1.5 A – 1 A	<120 µs (typical) (R <sub>load</sub> > 6Ω)
100 mA – 10 mA	<80 µs (typical)
1 mA	<100 µs (typical)
100 µA	<150 µs (typical)
10 µA	<500 µs (typical)
1 µA	<2 ms (typical)
100 nA	<20 ms (typical)
10 nA	<40 ms (typical)
1 nA	<150 ms (typical)

DC FLOATING VOLTAGE: Output can be floated up to ±250VDC.

REMOTE SENSE OPERATING RANGE<sup>10</sup>: Maximum voltage between HI and SENSE HI = 3V. Maximum voltage between LO and SENSE LO = 3V.

VOLTAGE OUTPUT HEADROOM:

200V Range: Max. output voltage = 202.3V – total voltage drop across source leads (maximum 1Ω per source lead).

20V Range: Max. output voltage = 23.3V – total voltage drop across source leads (maximum 1Ω per source lead).

OVER TEMPERATURE PROTECTION: Internally sensed temperature overload puts unit in standby mode.

VOLTAGE SOURCE RANGE CHANGE OVERSHOOT: <300mV + 0.1% of larger range (typical). Overshoot into a 200kΩ load, 20MHz BW.

CURRENT SOURCE RANGE CHANGE OVERSHOOT: <5% of larger range + 300mV/R<sub>load</sub> (typical – With source settling set to SETTLE\_SMOOTH\_100NA). See Current Source Output Settling Time for additional test conditions.

### PULSE SPECIFICATIONS

Region	Maximum Current Limit	Maximum Pulse Width <sup>11</sup>	Maximum Duty Cycle <sup>12</sup>
1	100 mA @ 200 V	DC, no limit	100%
1	1.5 A @ 20 V	DC, no limit	100%
2	1 A @ 180 V	8.5 ms	1%
3 <sup>13</sup>	1 A @ 200 V	2.2 ms	1%
4	10 A @ 5 V	1 ms	2.2%

MINIMUM PROGRAMMABLE PULSE WIDTH<sup>14, 15</sup>: 100µs. NOTE: Minimum pulse width for settled source at a given I/V output and load can be longer than 100µs.

PULSE WIDTH PROGRAMMING RESOLUTION: 1µs.

PULSE WIDTH PROGRAMMING ACCURACY<sup>15</sup>: ±5µs.

PULSE WIDTH JITTER: 50µs (typical).

QUADRANT DIAGRAM:

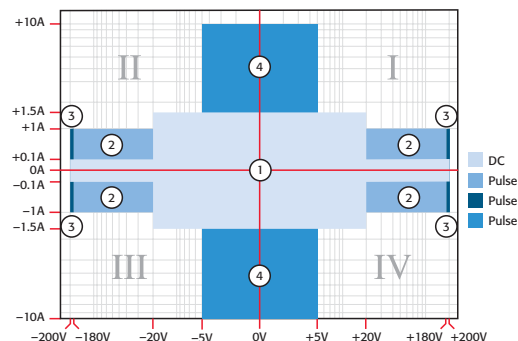

1.888.KEITHLEY (U.S. only)

www.keithley.com

KEITHLEY

# 2635A 2636A

# System SourceMeter® Instruments

Series 2600A specifications

SOURCE AND MEASURE

## SOURCE SPECIFICATIONS (continued)

### NOTES

1. Add 50μV to source accuracy specifications per volt of HI lead drop.
2. High Capacitance Mode accuracy is applicable at 23°C ±5°C only.
3. Full power source operation regardless of load to 30°C ambient. Above 30°C and/or power sink operation, refer to "Operating Boundaries" in the Series 2600A Reference Manual for additional power derating information.
4. For sink mode operation (quadrants II and IV), add 0.06% of limit range to the corresponding current limit accuracy specifications. Specifications apply with sink mode operation enabled.
5. Full power source operation regardless of load to 30°C ambient. Above 30°C and/or power sink operation, refer to "Operating Boundaries" in the Series 2600A Reference Manual for additional power derating information.
6. 10A range accessible only in pulse mode.
7. High Capacitance Mode accuracy is applicable at 23°C ±5°C only.
8. Full power source operation regardless of load to 30°C ambient. Above 30°C and/or power sink operation, refer to "Operating Boundaries" in the Series 2600A Reference Manual for additional power derating information.
9. For sink mode operation (quadrants II and IV), add 10% of compliance range and ±0.02% of limit setting to corresponding voltage source specification. For 200mV range add an additional 120mV of uncertainty.
10. Add 50μV to source accuracy specifications per volt of HI lead drop.
11. Times measured from the start of pulse to the start off-time; see figure below.

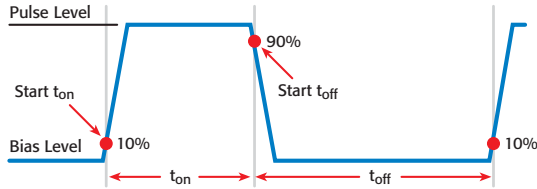

12. Thermally limited in sink mode (quadrants II and IV) and ambient temperatures above 30°C. See power equations in the Reference Manual for more information.
13. Voltage source operation with 1.5 A current limit.
14. Typical performance for minimum settled pulse widths:

Source Value	Load	Source Settling (% of range)	Min. Pulse Width
5 V	0.5 Ω	1%	300 μs
20 V	200 Ω	0.2%	200 μs
180 V	180 Ω	0.2%	5 ms
200 V (1.5 A Limit)	200 Ω	0.2%	1.5 ms
100 mA	200 Ω	1%	200 μs
1 A	200 Ω	1%	500 μs
1 A	180 Ω	0.2%	5 ms
10 A	0.5 Ω	0.5%	300 μs

Typical tests were performed using remote operation, 4W sense, and best, fixed measurement range. For more information on pulse scripts, see the Series 2600A Reference Manual.

15. Times measured from the start of pulse to the start off-time; see figure below.

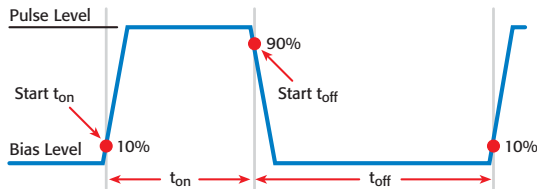

## METER SPECIFICATIONS

### VOLTAGE MEASUREMENT ACCURACY<sup>16, 17</sup>

Range	Display Resolution <sup>18</sup>	Input Resistance	Accuracy (1 Year) 23°C ±5°C ±(% rdg. + volts)
200.000 mV	1 μV	>10 <sup>14</sup> Ω	0.015% + 225 μV
2.00000 V	10 μV	>10 <sup>14</sup> Ω	0.02% + 350 μV
20.0000 V	100 μV	>10 <sup>14</sup> Ω	0.015% + 5 mV
200.000 V	1 mV	>10 <sup>14</sup> Ω	0.015% + 50 mV

TEMPERATURE COEFFICIENT (0°–18°C and 28°–50°C)<sup>19</sup>: ±(0.15 × accuracy specification)/°C. Applicable for normal mode only. Not applicable for high capacitance mode.

### CURRENT MEASUREMENT ACCURACY<sup>17</sup>

Range	Display Resolution <sup>20</sup>	Voltage Burden <sup>21</sup>	Accuracy (1 Year) 23°C ±5°C ±(% rdg. + amps)
100.00 pA <sup>22, 23</sup>	1 fA	<1 mV	0.15% + 120 fA
1.00000 nA <sup>22, 24</sup>	10 fA	<1 mV	0.15% + 240 fA
10.0000 nA	100 fA	<1 mV	0.15% + 3 pA
100.000 nA	1 pA	<1 mV	0.06% + 40 pA
1.00000 μA	10 pA	<1 mV	0.025% + 400 pA
10.0000 μA	100 pA	<1 mV	0.025% + 1.5 nA
100.000 μA	1 nA	<1 mV	0.02% + 25 nA
1.00000 mA	10 nA	<1 mV	0.02% + 200 nA
10.0000 mA	100 nA	<1 mV	0.02% + 2.5 μA
100.000 mA	1 μA	<1 mV	0.02% + 20 μA
1.00000 A	10 μA	<1 mV	0.03% + 1.5 mA
1.50000 A	10 μA	<1 mV	0.05% + 3.5 mA
10.0000 A <sup>25</sup>	100 μA	<1 mV	0.4% + 25 mA

CURRENT MEASURE SETTLE TIME (Time for measurement to settle after a Vstep)<sup>26</sup>: Time required to reach within 0.1% of final value after source level command is processed on a fixed range. Values for V<sub>out</sub> = 2V unless noted. Current Range: 1mA. Settling Time: <100μs (typical).

TEMPERATURE COEFFICIENT (0°–18°C and 28°–50°C)<sup>27</sup>: ±(0.15 × accuracy specification)/°C. Applicable for normal mode only. Not applicable for high capacitance mode.

### CONTACT CHECK<sup>28</sup>

Speed	Maximum Measurement Time to Memory For 60Hz (50Hz)	Accuracy (1 Year) 23°C ±5°C ±(%rdg. + ohms)
FAST	1 (1.2) ms	5% + 10 Ω
MEDIUM	4 (5) ms	5% + 1 Ω
SLOW	36 (42) ms	5% + 0.3 Ω

### ADDITIONAL METER SPECIFICATIONS

#### MAXIMUM LOAD IMPEDANCE:

Normal Mode: 10nF (typical). High Capacitance Mode: 50μF (typical).

COMMON MODE VOLTAGE: 250VDC.

COMMON MODE ISOLATION: >1GΩ, <4500pF.

OVERRRANGE: 101% of source range, 102% of measure range.

MAXIMUM SENSE LEAD RESISTANCE: 1kΩ for rated accuracy.

SENSE INPUT IMPEDANCE: >10<sup>14</sup>Ω.

1.888.KEITHLEY (U.S. only)

www.keithley.com

KEITHLEY

A GREATER MEASURE OF CONFIDENCE

# 2635A 2636A

# System SourceMeter® Instruments

## METER SPECIFICATIONS (continued)

### NOTES

16. Add 50µV to source accuracy specifications per volt of HI lead drop.  
17. Derate accuracy specifications for NPLC setting <1 by increasing error term. Add appropriate % of range term using table below.

NPLC Setting	200mV Range	2V–200V Ranges	100nA Range	1µA–100mA Ranges	1A–1.5A Ranges
0.1	0.01%	0.01%	0.01%	0.01%	0.01%
0.01	0.08%	0.07%	0.1%	0.05%	0.05%
0.001	0.8 %	0.6 %	1%	0.5 %	1.1 %

18. Applies when in single channel display mode.  
19. High Capacitance Mode accuracy is applicable at 23°C ±5°C only.  
20. Applies when in single channel display mode.  
21. Four-wire remote sense only and with current meter mode selected. Voltage measure set to 200mV or 2V range only.  
22. 10-NPLC, 11-Point Median Filter, <200V range, measurements made within 1 hour after zeroing. 23°C ± 1°C  
23. Under default specification conditions: ±(0.15% + 750fA).  
24. Under default specification conditions: ±(0.15% + 1pA).  
25. 10A range accessible only in pulse mode.  
26. Delay factor set to 1. Compliance equal to 100mA.  
27. High Capacitance Mode accuracy is applicable at 23°C ±5°C only.  
28. Includes measurement of SENSE HI to HI and SENSE LO to LO contact resistances.

## HIGH CAPACITANCE MODE 29, 30, 31

**VOLTAGE SOURCE OUTPUT SETTLING TIME:** Time required to reach within 0.1% of final value after source level command is processed on a fixed range. Current limit = 1A.

Voltage Source Range	Settling Time with $C_{load} = 4.7\mu F$
200 mV	600 µs (typical)
2 V	600 µs (typical)
20 V	1.5 ms (typical)
200 V	20 ms (typical)

**CURRENT MEASURE SETTLING TIME:** Time required to reach within 0.1% of final value after voltage source is stabilized on a fixed range. Values below for  $V_{out} = 2V$  unless noted.

Current Measure Range	Settling Time
1.5 A – 1 A	<120 µs (typical) ( $R_{load} > 6\Omega$ )
100 mA – 10 mA	<100 µs (typical)
1 mA	< 3 ms (typical)
100 µA	< 3 ms (typical)
10 µA	< 230 ms (typical)
1 µA	< 230 ms (typical)

**CAPACITOR LEAKAGE PERFORMANCE USING HIGH-C SCRIPTS 32:** Load = 5µF || 10MΩ.  
Test: 5V step and measure. 200ms (typical) @ 50nA.

### MODE CHANGE DELAY:

**100µA Current Range and Above:**  
Delay into High Capacitance Mode: 10ms.  
Delay out of High Capacitance Mode: 10ms.

**1µA and 10µA Current Ranges:**  
Delay into High Capacitance Mode: 230ms.  
Delay out of High Capacitance Mode: 10ms.

**VOLTMETER INPUT IMPEDANCE:** 30GΩ in parallel with 3300pF.

**NOISE, 10Hz–20MHz (20V Range):** <30mV peak-peak (typical).

**VOLTAGE SOURCE RANGE CHANGE OVERTHOOT (for 20V range and below):** <400mV + 0.1% of larger range (typical). Overshoot into a 200kΩ load, 20MHz BW.

### NOTES

29. High Capacitance Mode specifications are for DC measurements only.  
30. 100nA range and below are not available in high capacitance mode.  
31. High Capacitance Mode utilizes locked ranges. Auto Range is disabled.  
32. Part of KI Factory scripts. See reference manual for details.

**SEE PAGES 24 AND 25 FOR MEASUREMENT SPEEDS AND OTHER SPECIFICATIONS.**

## GENERAL

**IEEE-488:** IEEE-488.1 compliant. Supports IEEE-488.2 common commands and status model topology.

**RS-232:** Baud rates from 300bps to 115200bps. Programmable number of data bits, parity type, and flow control (RTS/CTS hardware or none). When not programmed as the active host interface, the SourceMeter instrument can use the RS-232 interface to control other instrumentation.

**ETHERNET:** RJ-45 connector, LXI Class C, 10/100BT, no auto MDIX.

**EXPANSION INTERFACE:** The TSP-Link expansion interface allows TSP enabled instruments to trigger and communicate with each other.

**Cable Type:** Category 5e or higher LAN crossover cable.

**Length:** 3 meters maximum between each TSP enabled instrument.

**LXI COMPLIANCE:** LXI Class C 1.2.

**LXI TIMING:** Total Output Trigger Response Time: 245µs min., 280µs typ., (not specified) max. Receive LAN[0-7] Event Delay: Unknown. Generate LAN[0-7] Event Delay: Unknown.

### DIGITAL I/O INTERFACE:

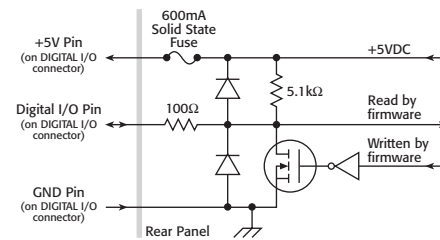

**Connector:** 25-pin female D.

**Input/Output Pins:** 14 open drain I/O bits.

**Absolute Maximum Input Voltage:** 5.25V.

**Absolute Minimum Input Voltage:** -0.25V.

**Maximum Logic Low Input Voltage:** 0.7V, +850µA max.

**Minimum Logic High Input Voltage:** 2.1V, +570µA.

**Maximum Source Current (flowing out of Digital I/O bit):** +960µA.

**Maximum Sink Current @ Maximum Logic Low Voltage (0.7V):** -5.0mA.

**Absolute Maximum Sink Current (flowing into Digital I/O pin):** -11mA.

**5V Power Supply Pin:** Limited to 600mA, solid state fuse protected.

**Safety Interlock Pin:** Active high input. >3.4V @ 24mA (absolute maximum of 6V) must be externally applied to this pin to ensure 200V operation. This signal is pulled down to chassis ground with a 10kΩ resistor. 200V operation will be blocked when the INTERLOCK signal is <0.4V (absolute minimum -0.4V). See figure below:

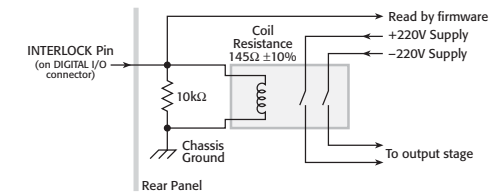

**USB:** USB 1.0 Host Controller (Memory Stick I/O).

**POWER SUPPLY:** 100V to 250VAC, 50–60Hz (auto sensing), 240VA max.

**COOLING:** Forced air. Side intake and rear exhaust. One side must be unobstructed when rack mounted.

**EMC:** Conforms to European Union Directive 2004/108/EEC, EN 61326-1.

**SAFETY:** Conforms to European Union Directive 73/23/EEC, EN 61010-1, and UL 61010-1.

**DIMENSIONS:** 89mm high × 213mm wide × 460mm deep (3½ in × 8½ in × 17½ in). Bench Configuration (with handle and feet): 104mm high × 238mm wide × 460mm deep (4½ in × 9½ in × 17½ in).

**WEIGHT:** 2635A: 4.75kg (10.4 lbs). 2636A: 5.50kg (12.0 lbs).

**ENVIRONMENT:** For indoor use only. **Altitude:** Maximum 2000 meters above sea level.

**Operating:** 0°–50°C, 70% R.H. up to 35°C. Derate 3% R.H./°C, 35°–50°C.

**Storage:** -25°C to 65°C.

1.888.KEITHLEY (U.S. only)

www.keithley.com

KEITHLEY

# Series 2600A

# System SourceMeter® Instruments

Applicable to Models

2601A, 2602A, 2611A, 2612A, 2635A, and 2636A

## MEASUREMENT SPEED SPECIFICATIONS <sup>1, 2, 3</sup>

### MAXIMUM SWEEP OPERATION RATES (operations per second) FOR 60Hz (50Hz):

A/D Converter Speed	Trigger Origin	Measure To Memory Using User Scripts	Measure To GPIB Using User Scripts	Source Measure To Memory Using User Scripts	Source Measure To GPIB Using User Scripts	Source Measure To Memory Using Sweep API	Source Measure To GPIB Using Sweep API
0.001 NPLC	Internal	20000 (20000)	10500 (10500)	7000 (7000)	6200 (6200)	12000 (12000)	5900 (5900)
0.001 NPLC	Digital I/O	8100 (8100)	7100 (7100)	5500 (5500)	5100 (5100)	11200 (11200)	5700 (5700)
0.01 NPLC	Internal	5000 (4000)	4000 (3500)	3400 (3000)	3200 (2900)	4200 (3700)	3100 (2800)
0.01 NPLC	Digital I/O	3650 (3200)	3400 (3000)	3000 (2700)	2900 (2600)	4150 (3650)	3050 (2775)
0.1 NPLC	Internal	580 (490)	560 (475)	550 (465)	550 (460)	575 (480)	545 (460)
0.1 NPLC	Digital I/O	560 (470)	450 (460)	545 (460)	540 (450)	570 (480)	545 (460)
1.0 NPLC	Internal	59 (49)	59 (49)	59 (49)	59 (49)	59 (49)	59 (49)
1.0 NPLC	Digital I/O	58 (48)	58 (49)	59 (49)	59 (49)	59 (49)	59 (49)

### MAXIMUM SINGLE MEASUREMENT RATES (operations per second) FOR 60Hz (50Hz):

A/D Converter Speed	Trigger Origin	Measure To GPIB	Source Measure To GPIB	Source Measure Pass/Fail To GPIB
0.001 NPLC	Internal	1900 (1800)	1400 (1400)	1400 (1400)
0.01 NPLC	Internal	1450 (1400)	1200 (1100)	1100 (1100)
0.1 NPLC	Internal	450 (390)	425 (370)	425 (375)
1.0 NPLC	Internal	58 (48)	57 (48)	57 (48)

MAXIMUM MEASUREMENT RANGE CHANGE RATE: <150µs for ranges >10µA, typical. When changing to or from a range ≥1A, maximum rate is <450µs, typical.

MAXIMUM SOURCE RANGE CHANGE RATE: <2.5ms for ranges >10µA, typical. When changing to or from a range ≥1A, maximum rate is <5.2ms, typical.

MAXIMUM SOURCE FUNCTION CHANGE RATE: <1ms, typical.

COMMAND PROCESSING TIME: Maximum time required for the output to begin to change following the receipt of the smux.source.level or smux.source.level command. <1ms typical.

### NOTES

1. Tests performed with a 2602A, 2612A, or 2636A on Channel A using the following equipment: PC Hardware (Pentium® 4 2.4GHz, 512MB RAM, National Instruments PCI-GPIB). Driver (NI-486.2 Version 2.2 PCI-GPIB). Software (Microsoft® Windows® 2000, Microsoft Visual Studio 2005, VISA version 4.1).
2. Exclude current measurement ranges less than 1mA.
3. 2635A/2636A with default measurement delays and filters disabled.

## TRIGGERING AND SYNCHRONIZATION SPECIFICATIONS

### TRIGGERING:

- Trigger in to trigger out: 0.5µs, typical.
- Trigger in to source change:<sup>4</sup> 10 µs, typical.
- Trigger Timer accuracy: ±2µs, typical.
- Source change<sup>4</sup> after LXI Trigger: 280µs, typical.

### SYNCHRONIZATION:

- Single-node synchronized source change:<sup>4</sup> <0.5µs, typical.
- Multi-node synchronized source change:<sup>4</sup> <0.5µs, typical.

### NOTES

4. Fixed source range, with no polarity change.

1.888.KEITHLEY (U.S. only)

www.keithley.com

KEITHLEY

A GREATER MEASURE OF CONFIDENCE

# Series 2600A

# System SourceMeter® Instruments

## Applicable to Models

2601A, 2602A, 2611A, 2612A, 2635A, and 2636A

## SUPPLEMENTAL INFORMATION

**FRONT PANEL INTERFACE:** Two-line vacuum fluorescent display (VFD) with keypad and rotary knob.

### Display:

- Show error messages and user defined messages
- Display source and limit settings
- Show current and voltage measurements
- View measurements stored in dedicated reading buffers

### Keypad Operations:

- Change host interface settings
- Save and restore instrument setups
- Load and run factory and user defined test scripts (i.e. sequences) that prompt for input and send results to the display
- Store measurements into dedicated reading buffers

**PROGRAMMING:** Embedded Test Script Processor (TSP) accessible from any host interface. Responds to individual instrument control commands. Responds to high speed test scripts comprised of instrument control commands and Test Script Language (TSL) statements (e.g. branching, looping, math, etc.). Able to execute high speed test scripts stored in memory without host intervention.

**Minimum Memory Available:** 16MB (approximately 250,000 lines of TSL code).

**Test Script Builder:** Integrated development environment for building, running, and managing TSP scripts. Includes an instrument console for communicating with any TSP enabled instrument in an interactive manner. Requires:

- VISA (NI-VISA included on CD)
- Microsoft .NET Framework (included on CD)
- Keithley I/O Layer (included on CD)
- Pentium III 800MHz or faster personal computer
- Microsoft Windows 98, NT, 2000, or XP

**Software Interface:** TSP Express (embedded), Direct GPIB/VISA, READ/WRITE for VB, VC/C++, LabVIEW, LabWindows/CVI, etc.

**READING BUFFERS:** Dedicated storage area(s) reserved for measurement data. Reading buffers are arrays of measurement elements. Each element can hold the following items:

- Measurement
- Measurement status
- Timestamp
- Source setting (at the time the measurement was taken)
- Range information

Two reading buffers are reserved for each SourceMeter channel. Reading buffers can be filled using the front panel STORE key and retrieved using the RECALL key or host interface.

**Buffer Size, with timestamp and source setting:** >60,000 samples.

**Buffer Size, without timestamp and source setting:** >140,000 samples.

**SYSTEM EXPANSION:** The TSP-Link expansion interface allows TSP enabled instruments to trigger and communicate with each other. See figure below:

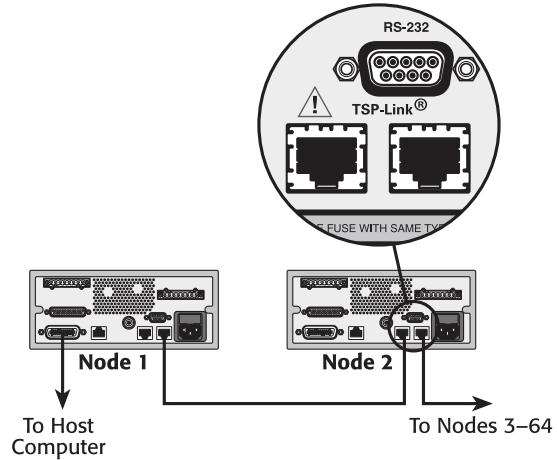

Each SourceMeter instrument has two TSP-Link connectors to facilitate chaining instruments together.

- Once SourceMeter instruments are interconnected via TSP-Link, a computer can access all of the resources of each SourceMeter instrument via the host interface of any SourceMeter instrument.
- A maximum of 32 TSP-Link nodes can be interconnected. Each SourceMeter instrument consumes one TSP-Link node.

**TIMER:** Free running 47-bit counter with 1MHz clock input. Reset each time instrument powers up. Rolls over every 4 years.

**Timestamp:** TIMER value automatically saved when each measurement is triggered.

**Resolution:** 1 $\mu$ s.

**Accuracy:**  $\pm$ 100ppm.

1.888.KEITHLEY (U.S. only)

www.keithley.com

KEITHLEY